

2a

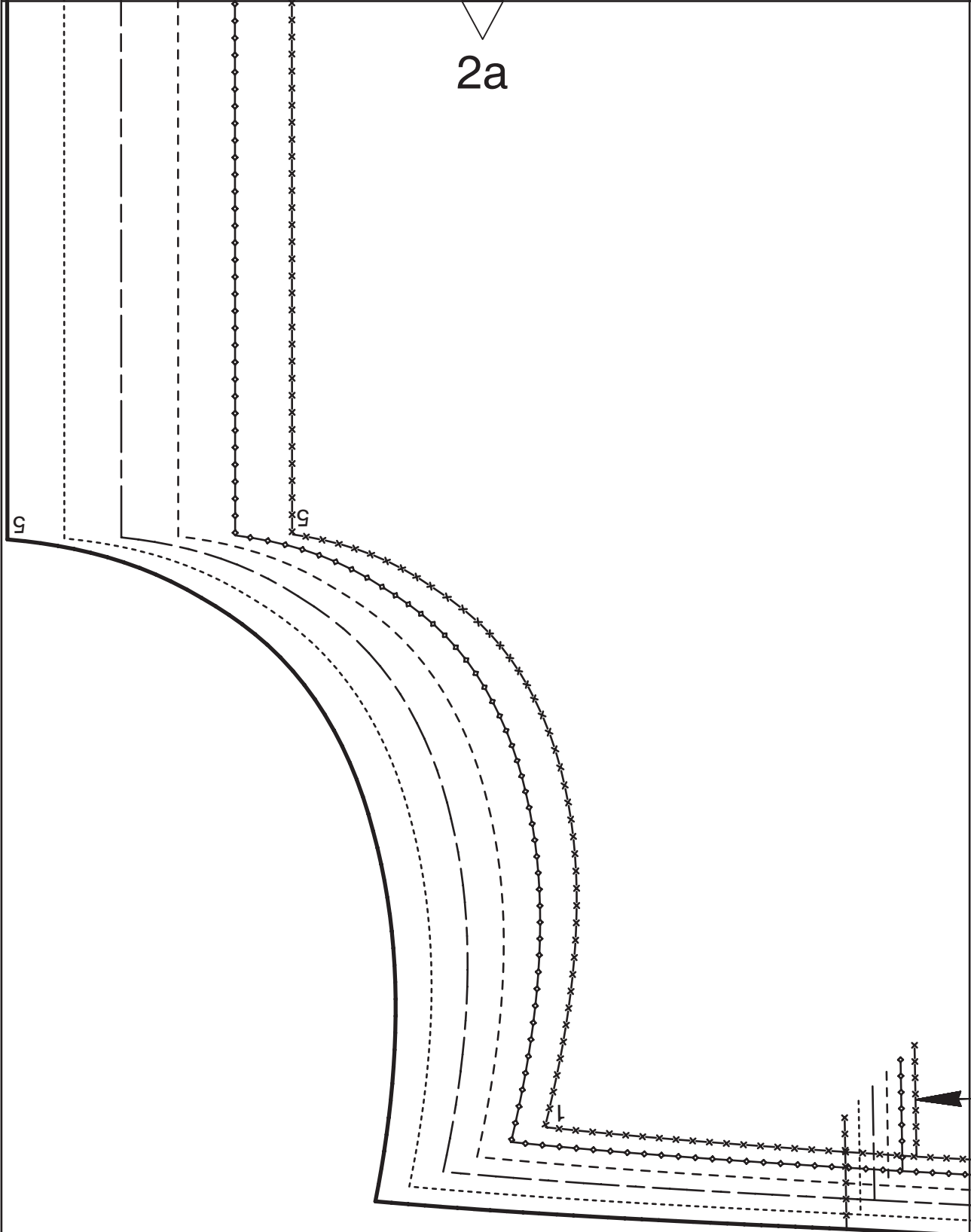

1a

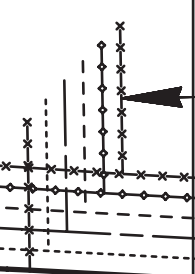

2b

2

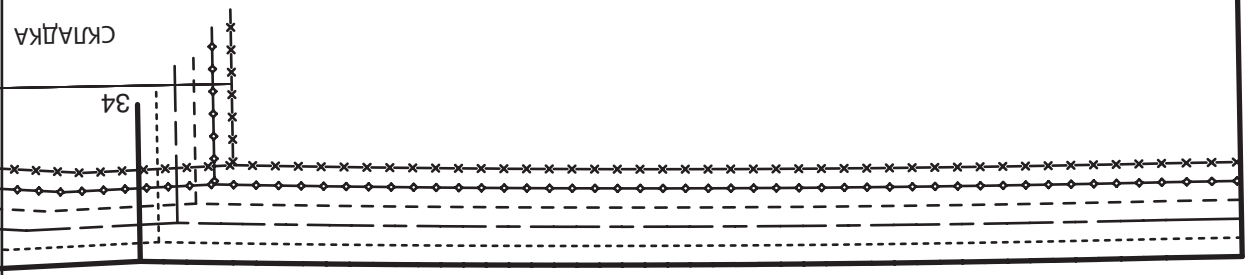

1a

1b

2c



1c

6.

1b

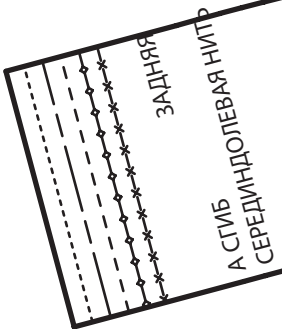

2d

ПОЛОСКА

1c

1d

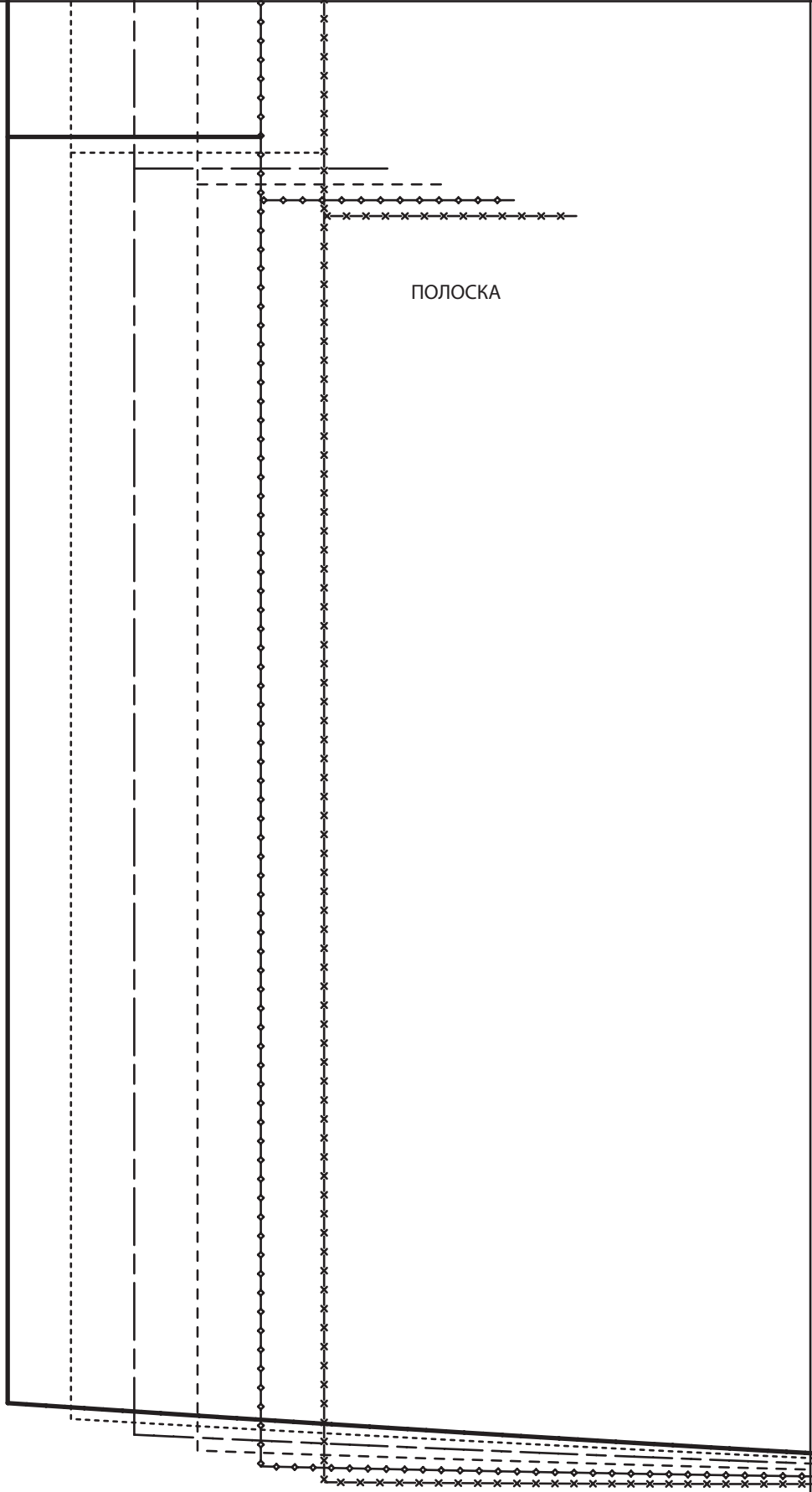

2e

.107

1d

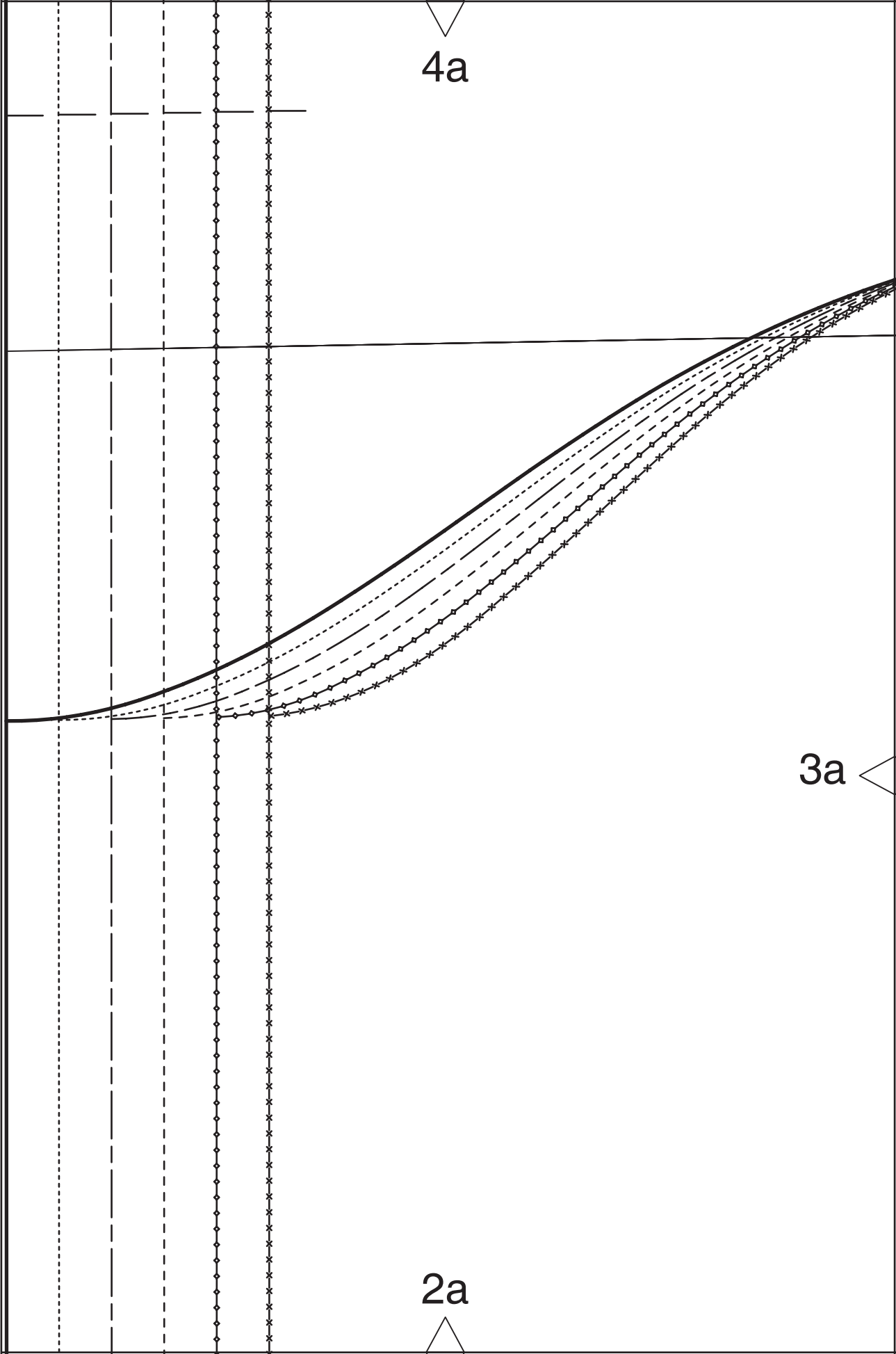

4b

105

107

106

КУЛНКА

106, 107

3a

3b

2b

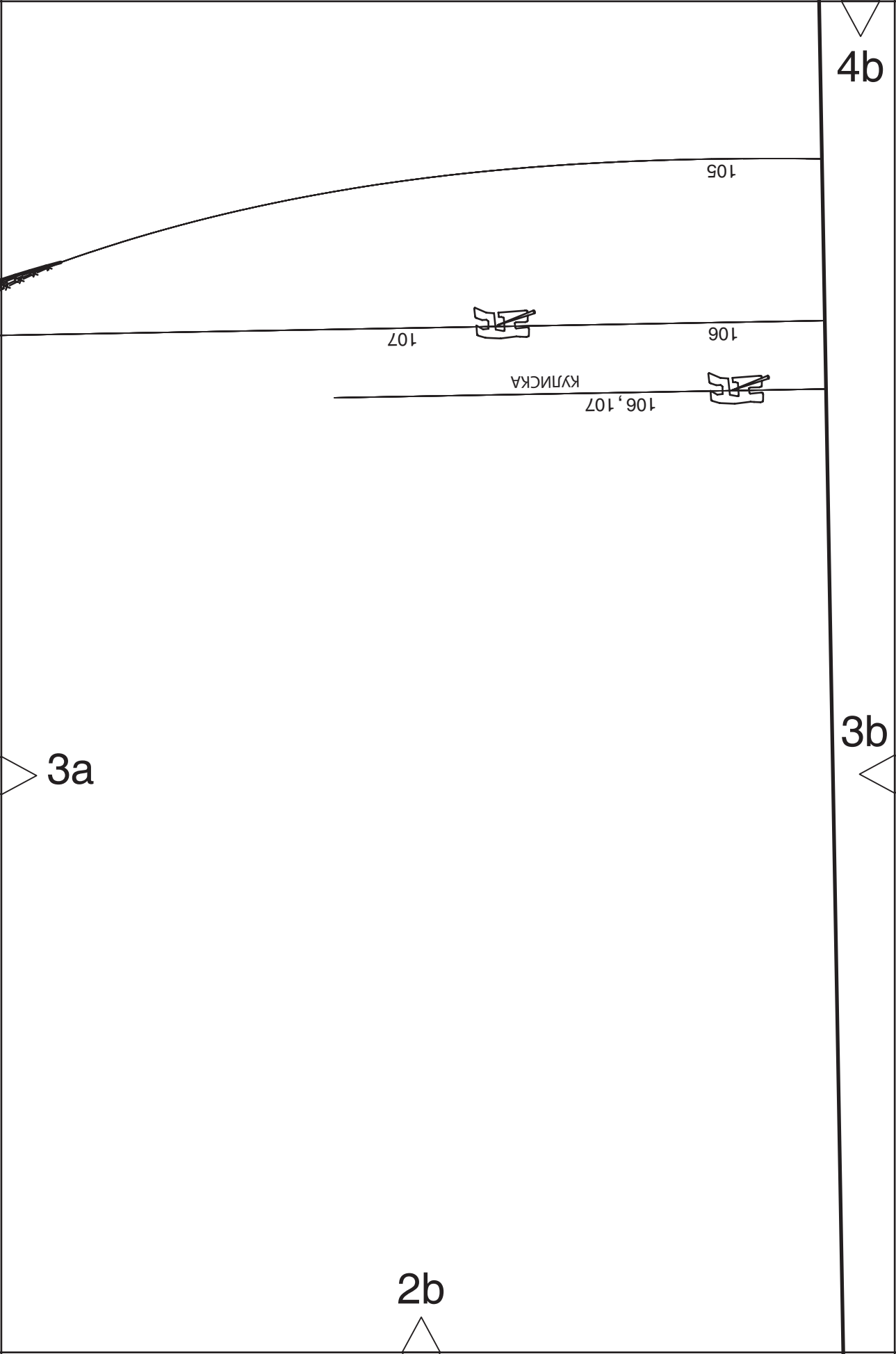

4c

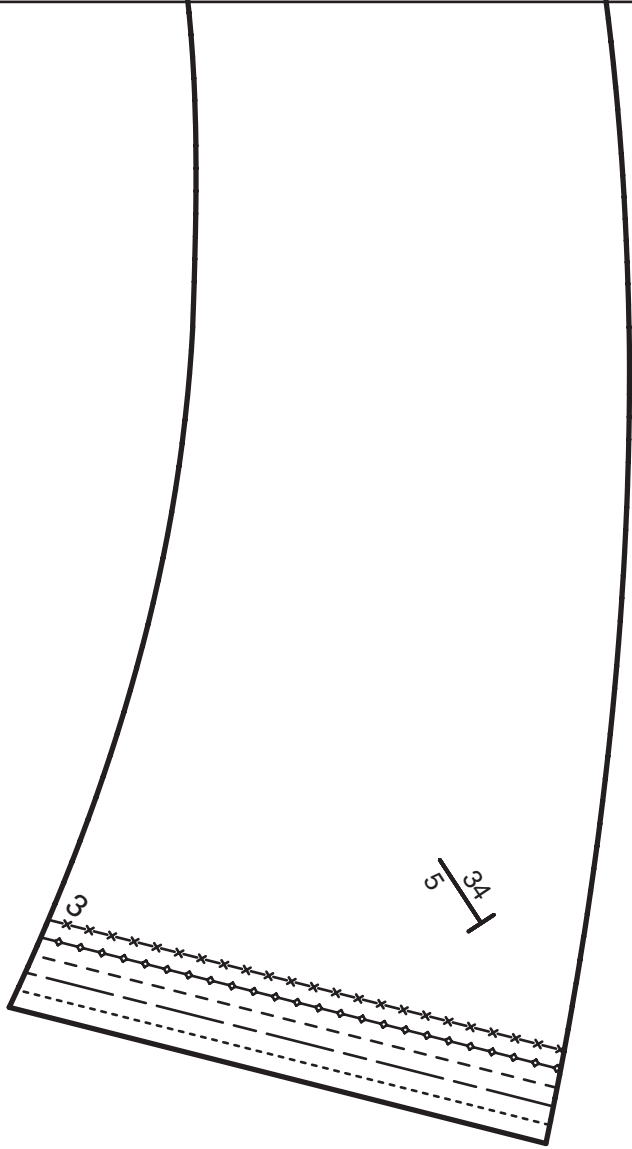

5
34

3

3b

3c

2c

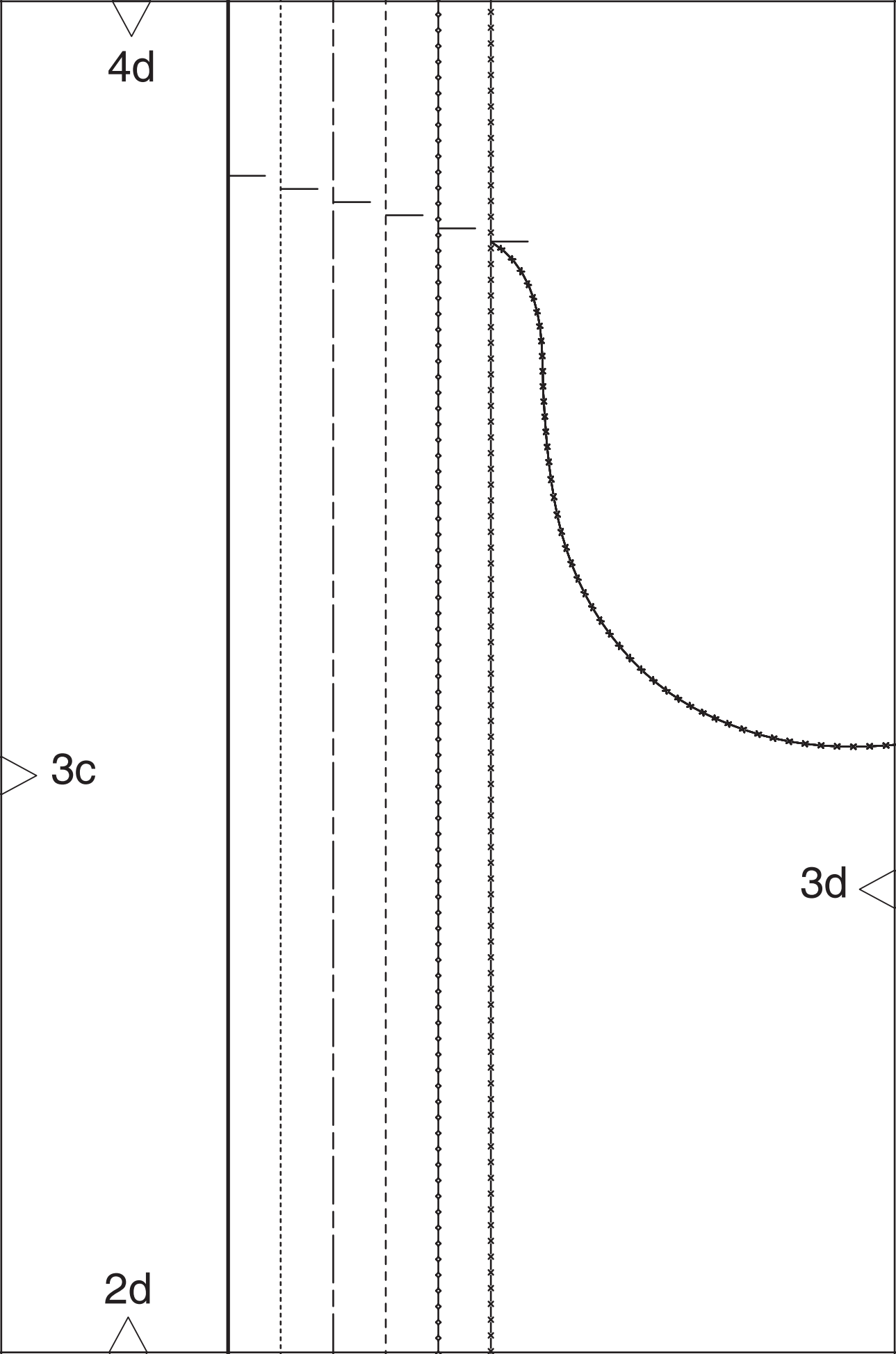

4e

МЕШКОВИНА
КАРМАНА

2e

3d

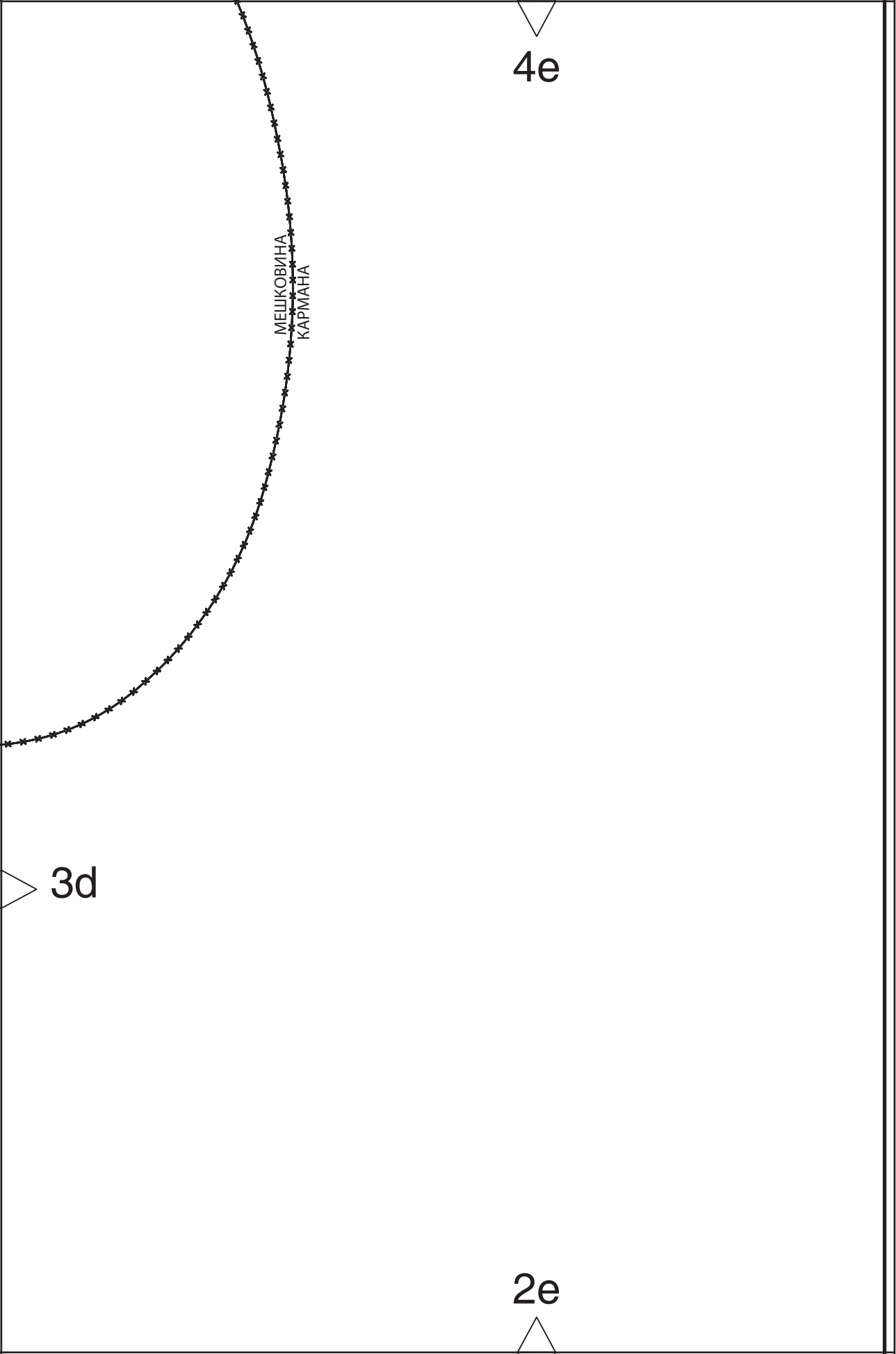

6a

5a

4a

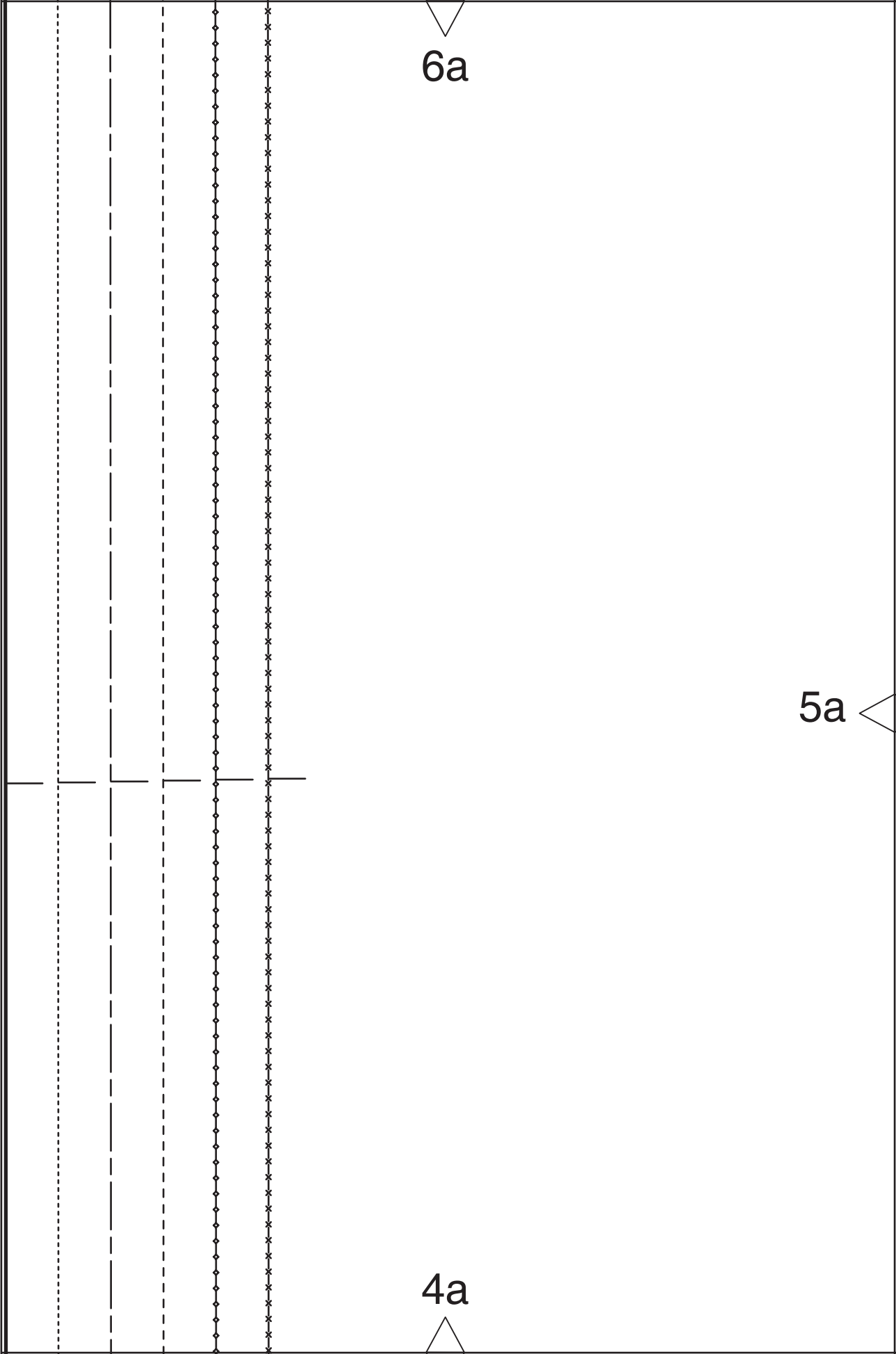

6b

5b

5a

4b

6c

5b

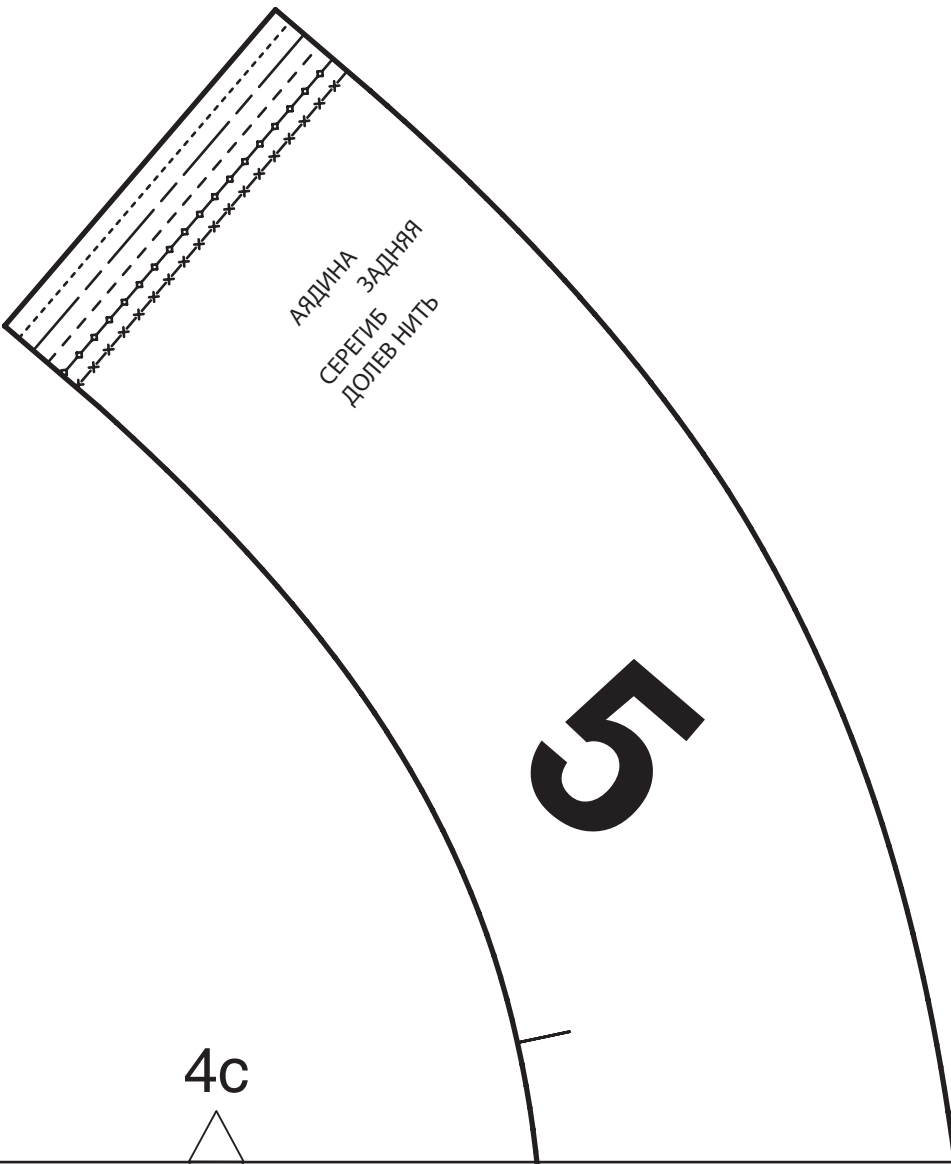

5c

4c

6d

5d

5c

4d

ВХОД В КАРМАН

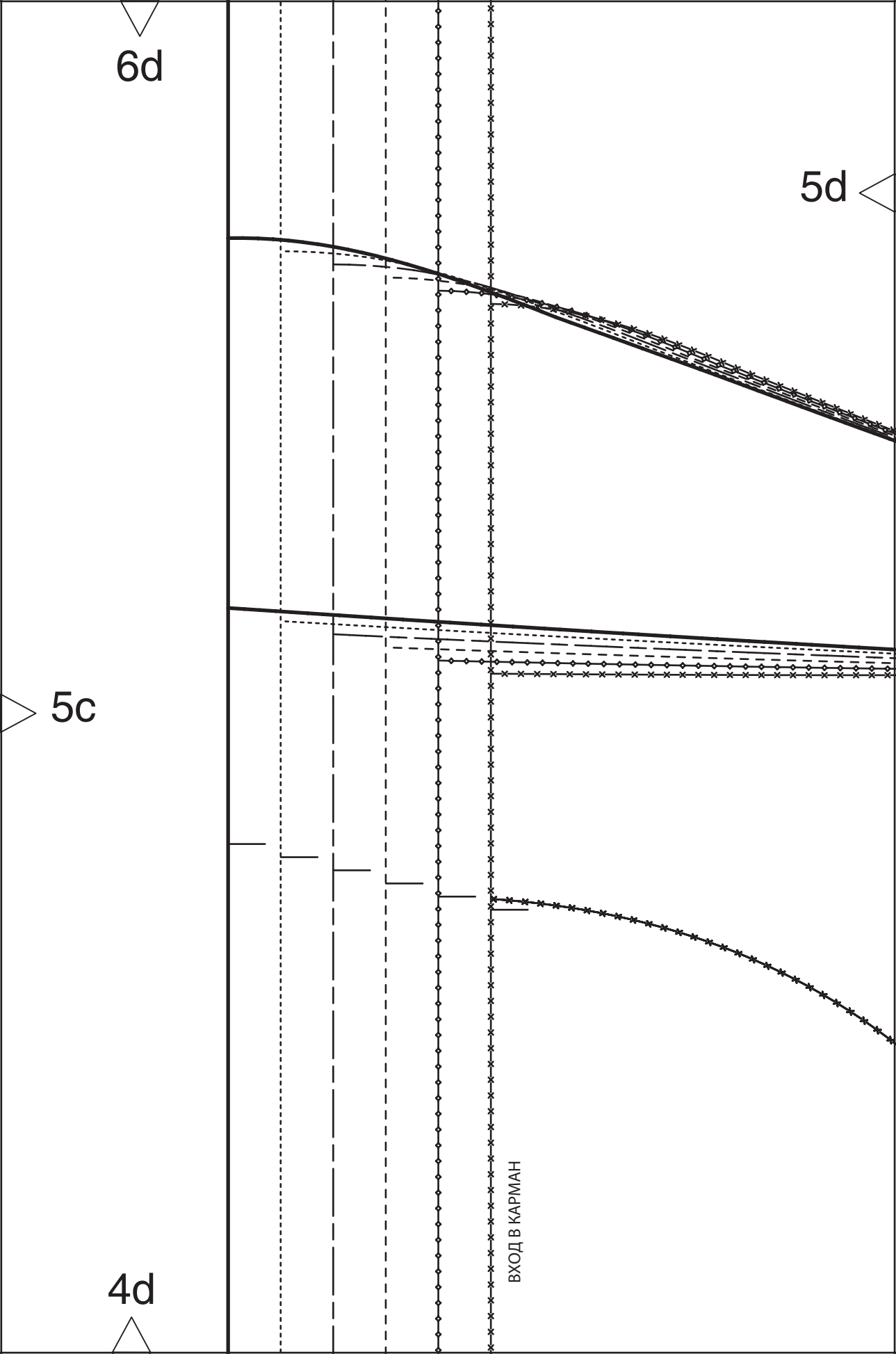

6e

5d

106, 107

105

106, 107

КУЛИСКА

106

107

4e

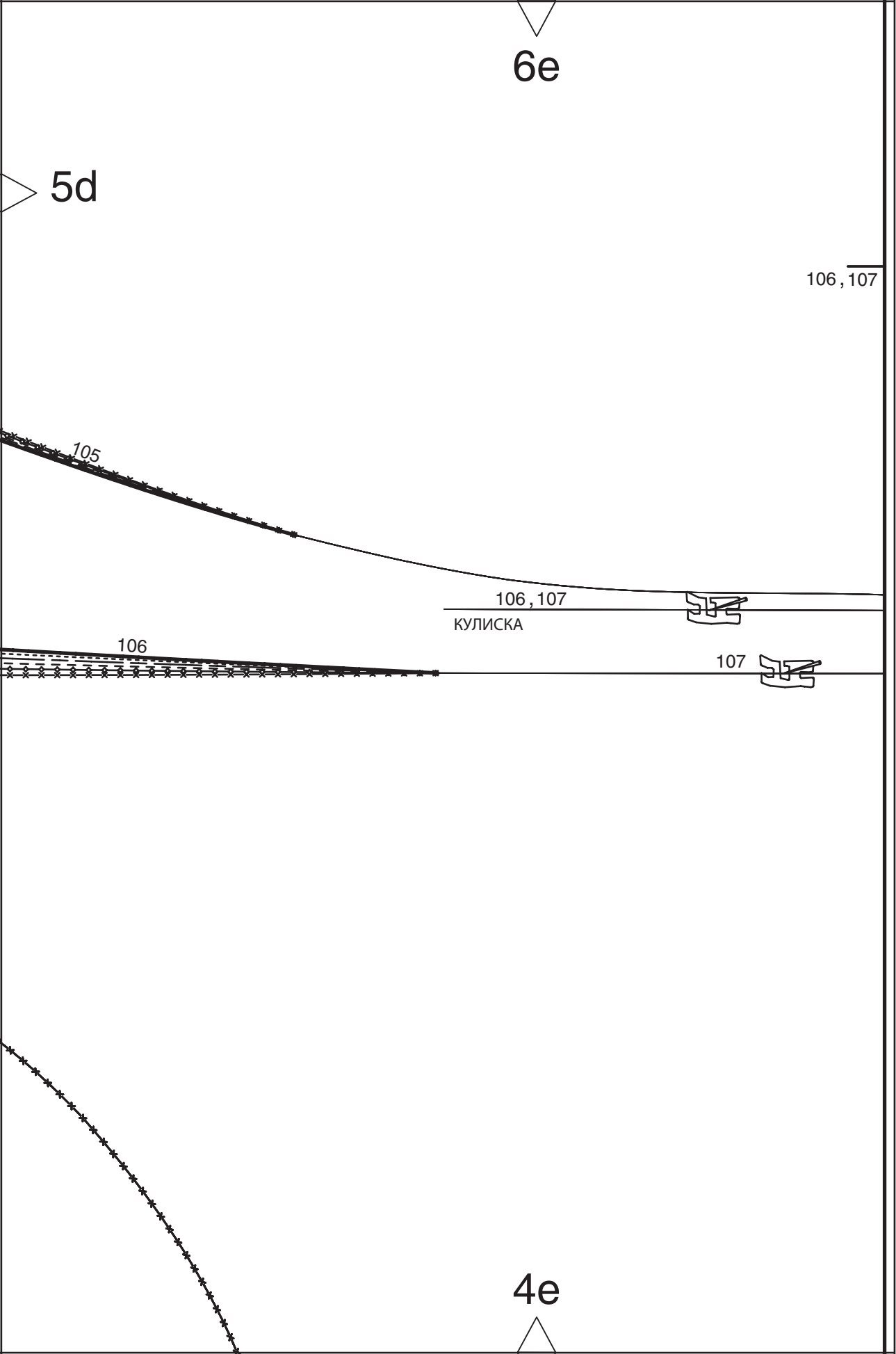

8a

7a

ПОЛОСКА

6a

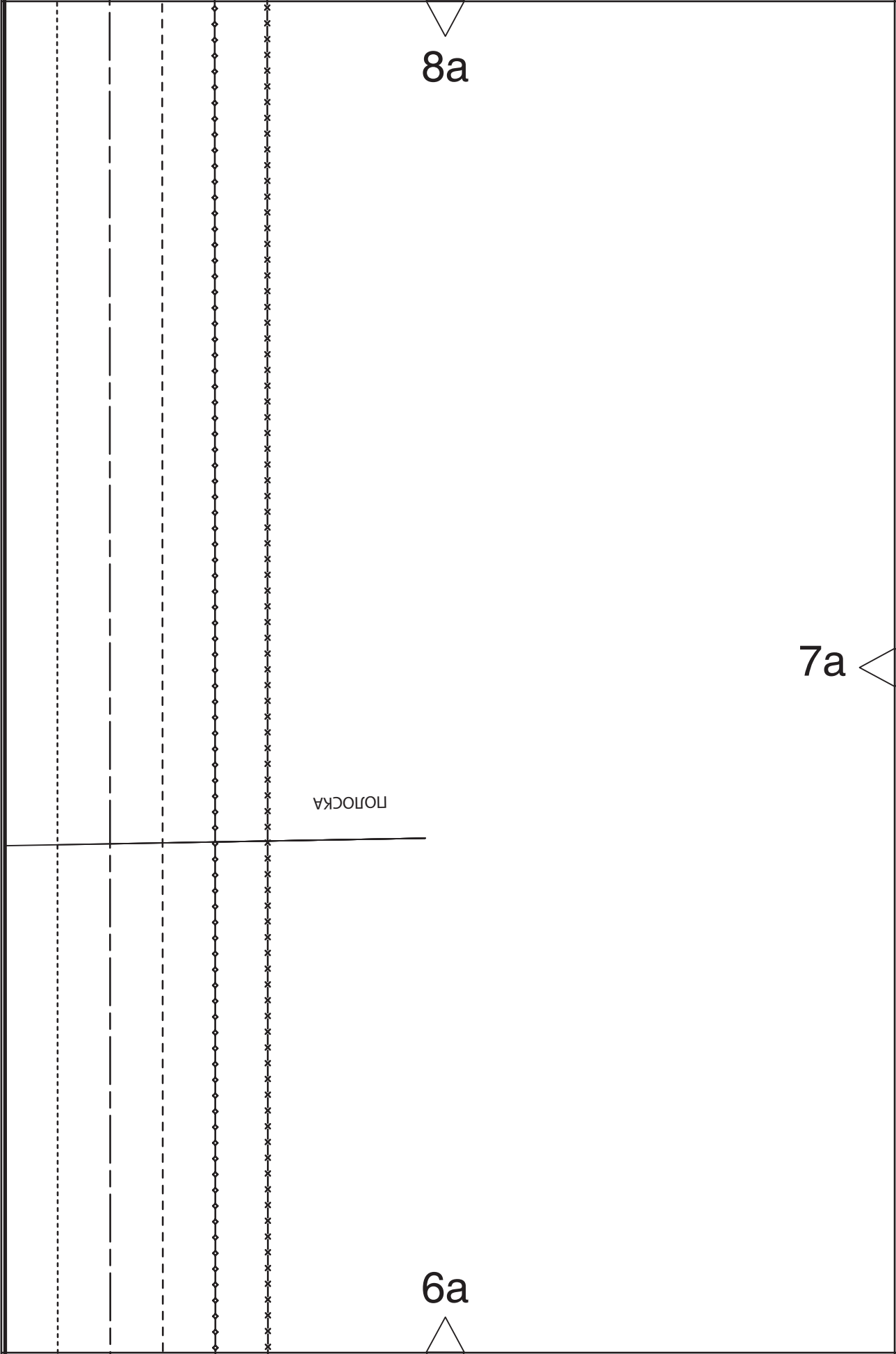

8b

7a

7b

6b

8c

7b

7c

10 cm

6c

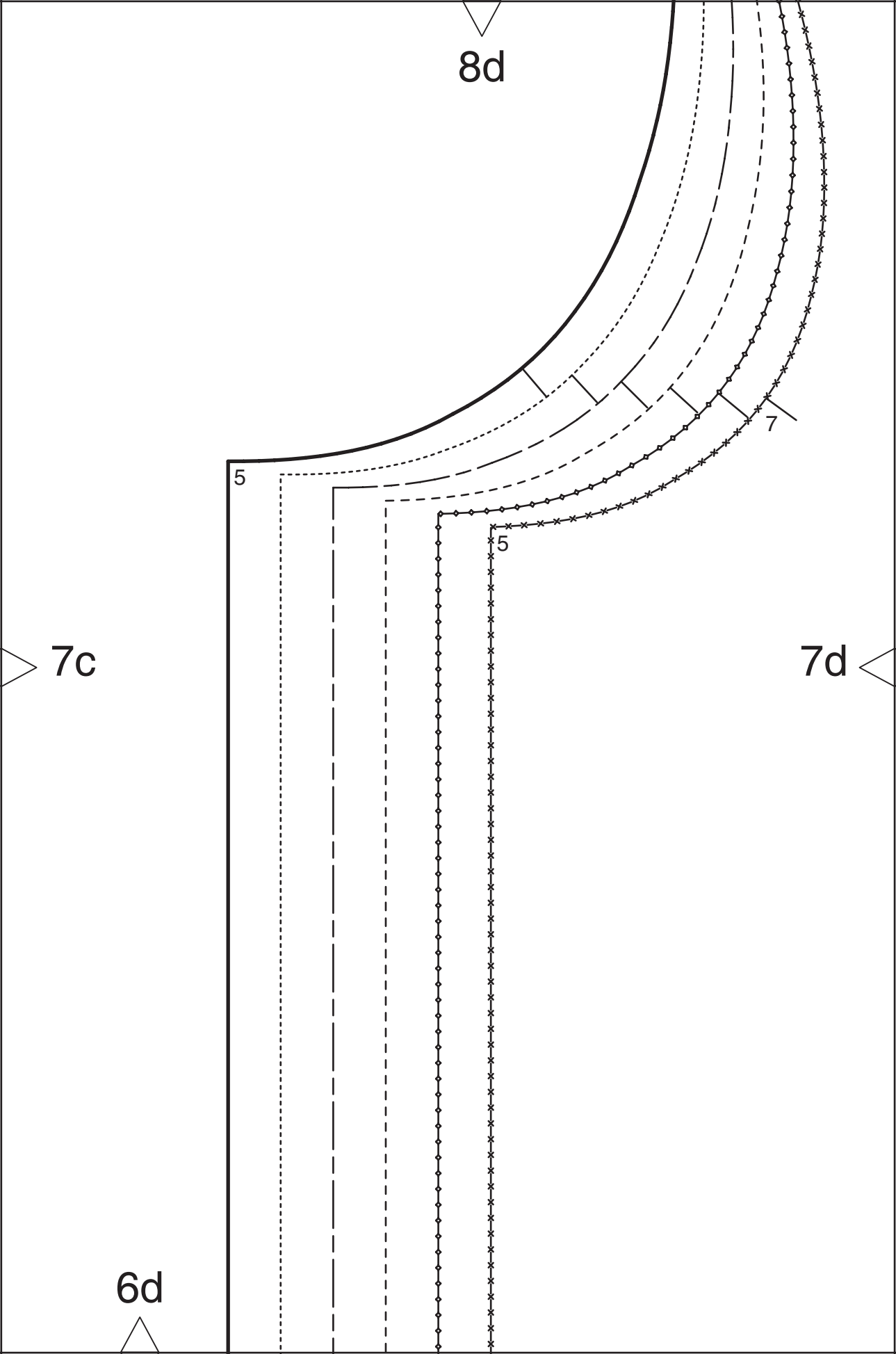

1

7d

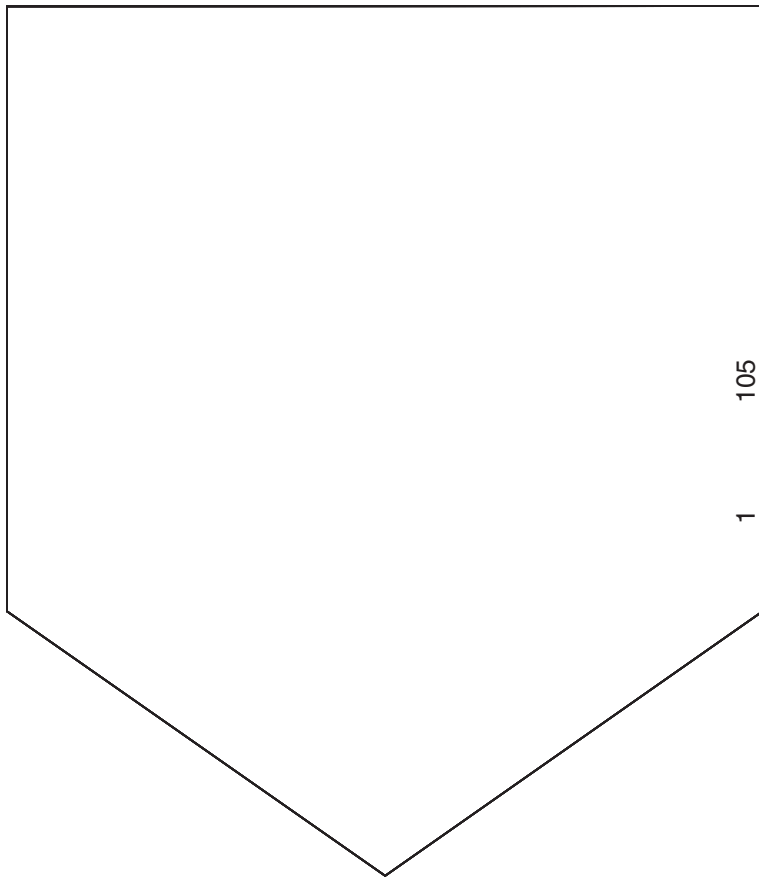

105

ЛЕВАЯ
СТОРОНА

КАРМАН

1

6e

8e

105



ЛИНИЯ СЕРЕДИНЫ ПЕРЕДА ШОВ ДОЛЕВАЯ НИТЬ

ШЛИЦА, РАЗРЕЗ

10a



ГРИСБОРИТЪ

9a

8a

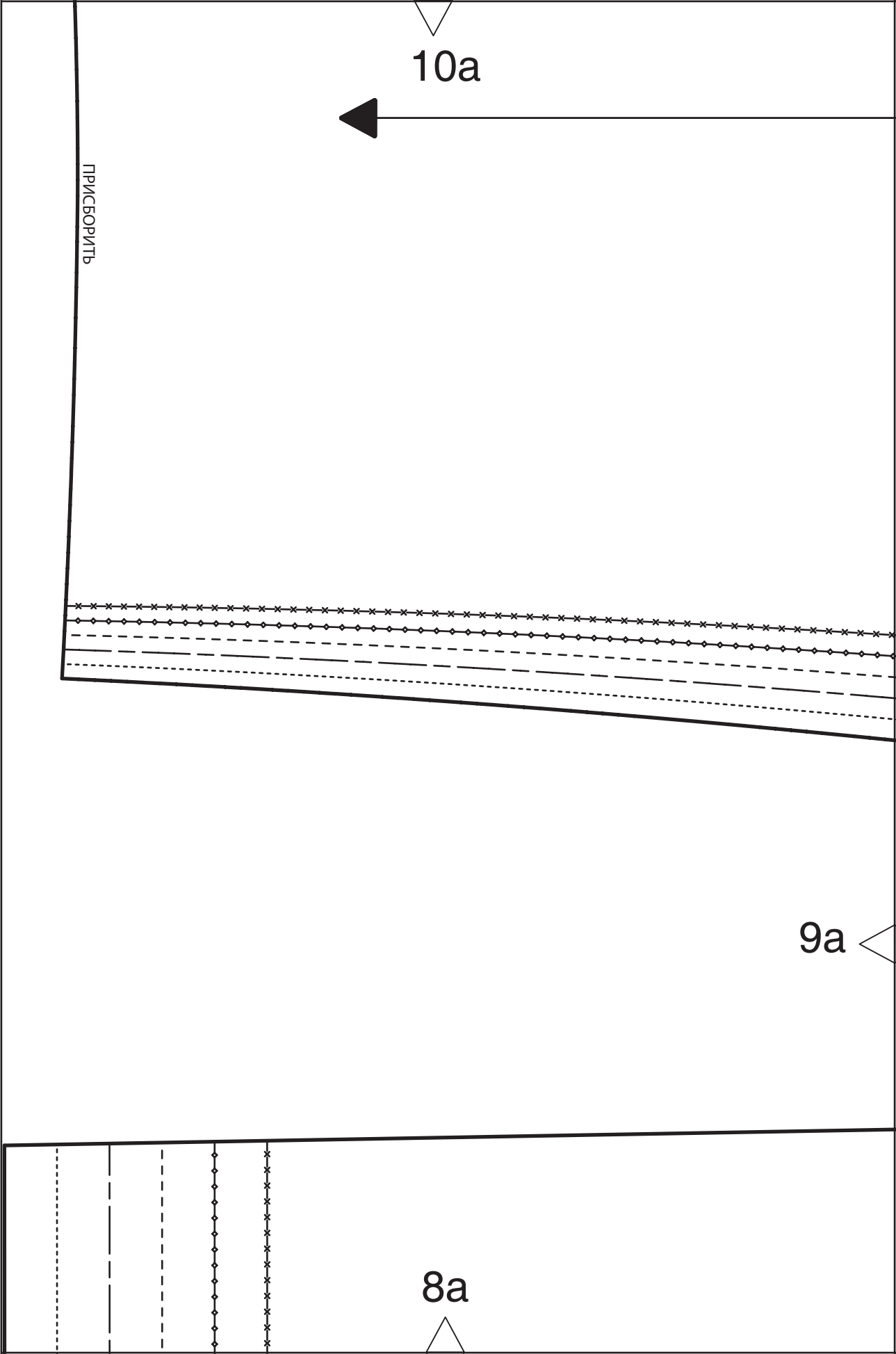

10b

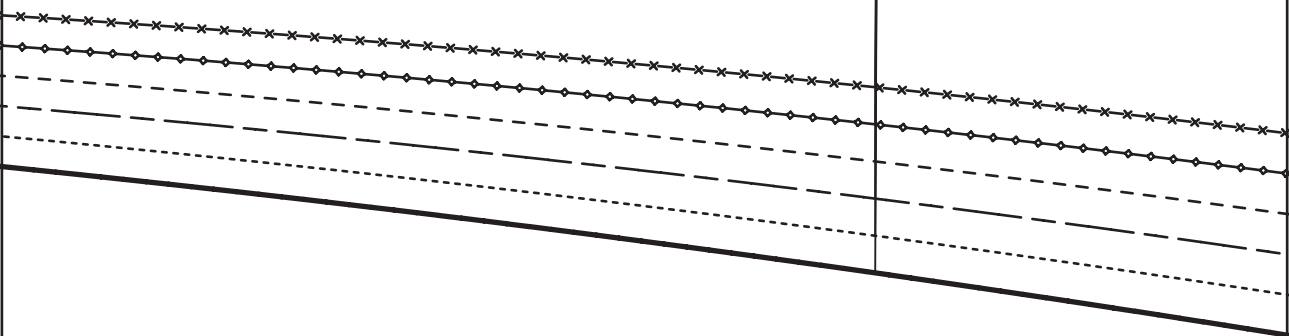

9a

9b

107

8b

10с

ДОЛЕВАЯ
НИТЬ

9с

9

9b

ЗАДНЯЯ СРЕДНЯЯ СЛОИТЬ

ДОЛЕВАЯ НИТЬ

8с

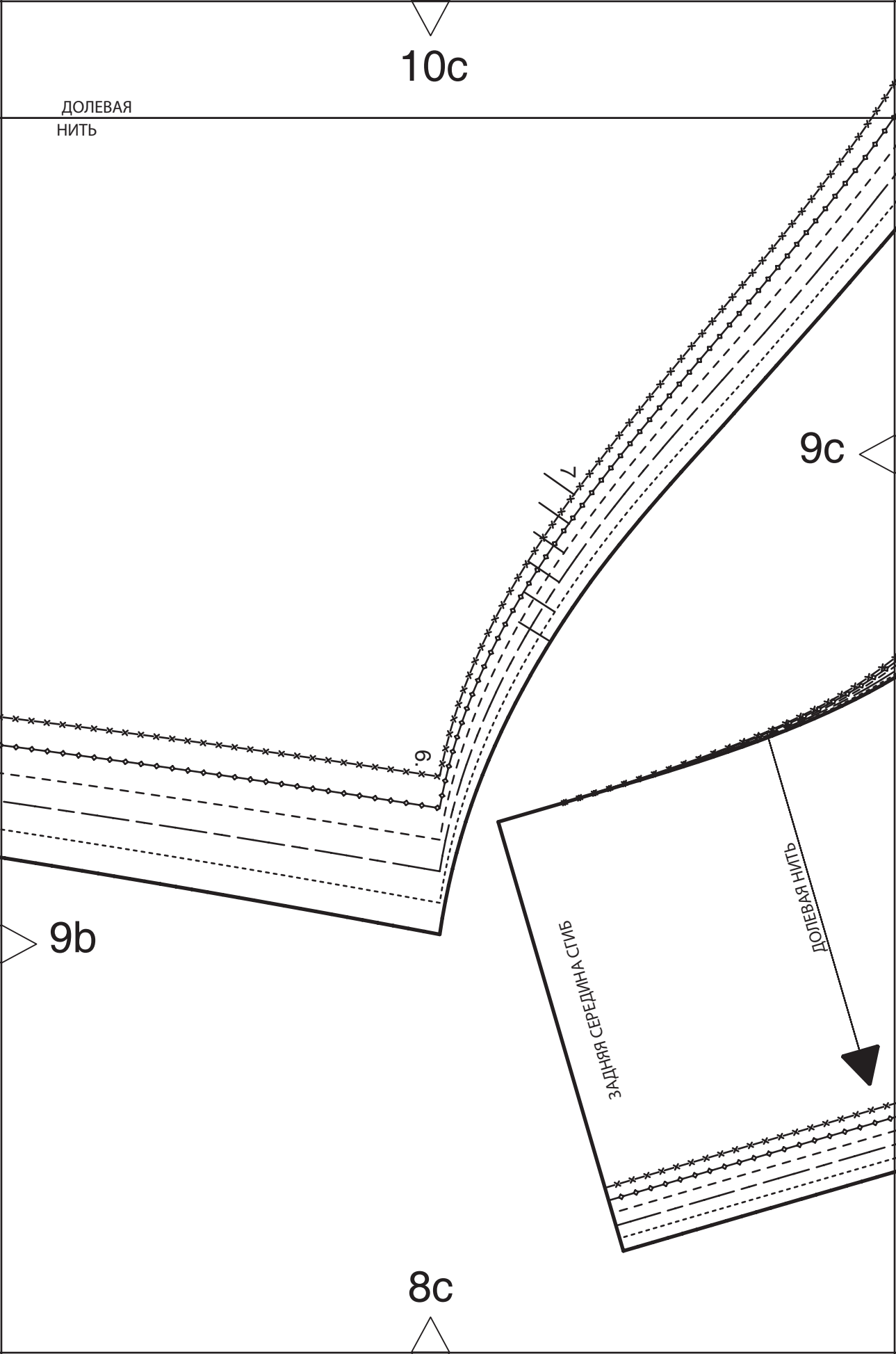

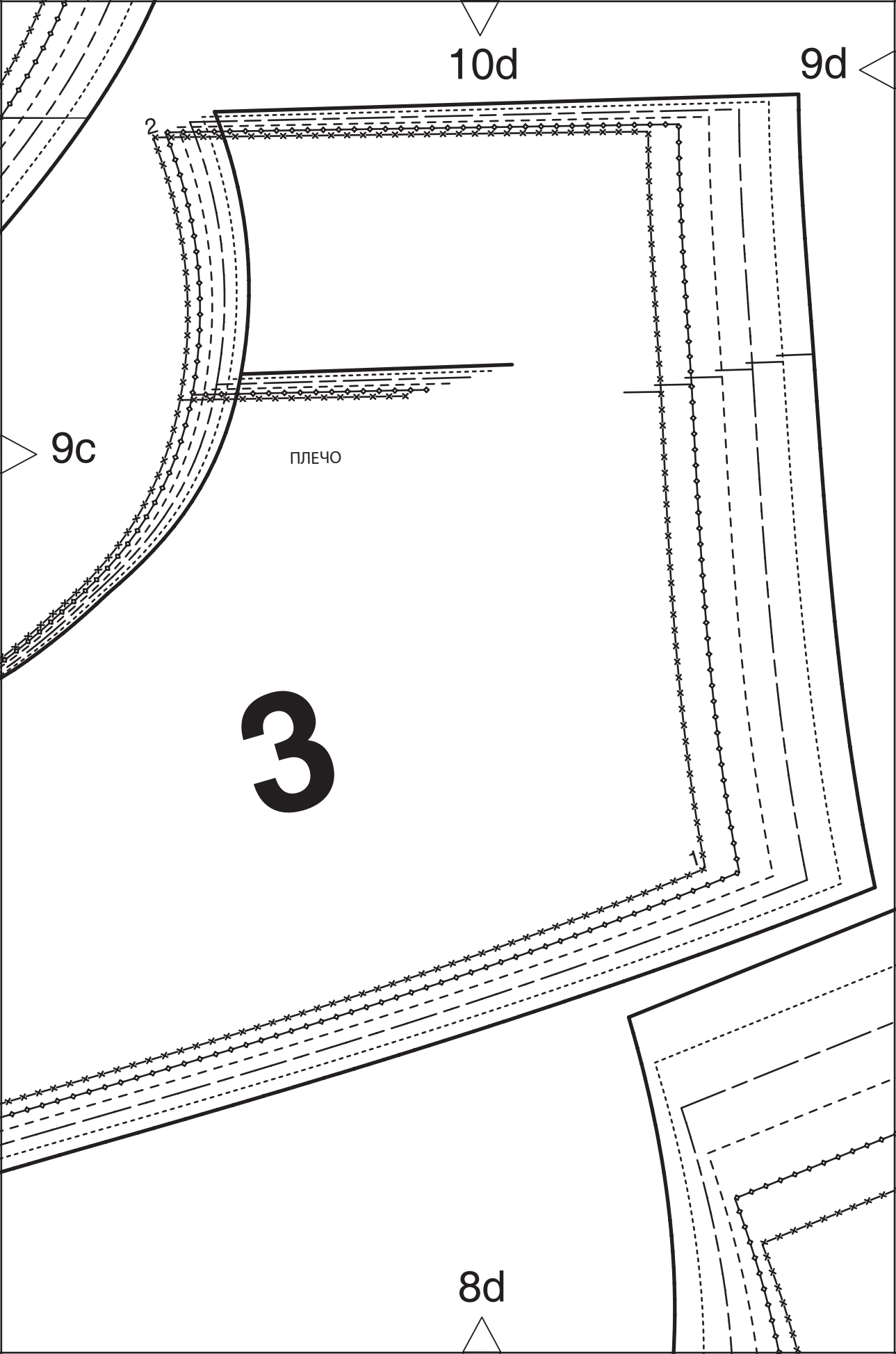

10d

9d

9c

ПЛЕЧО

3

2

8d

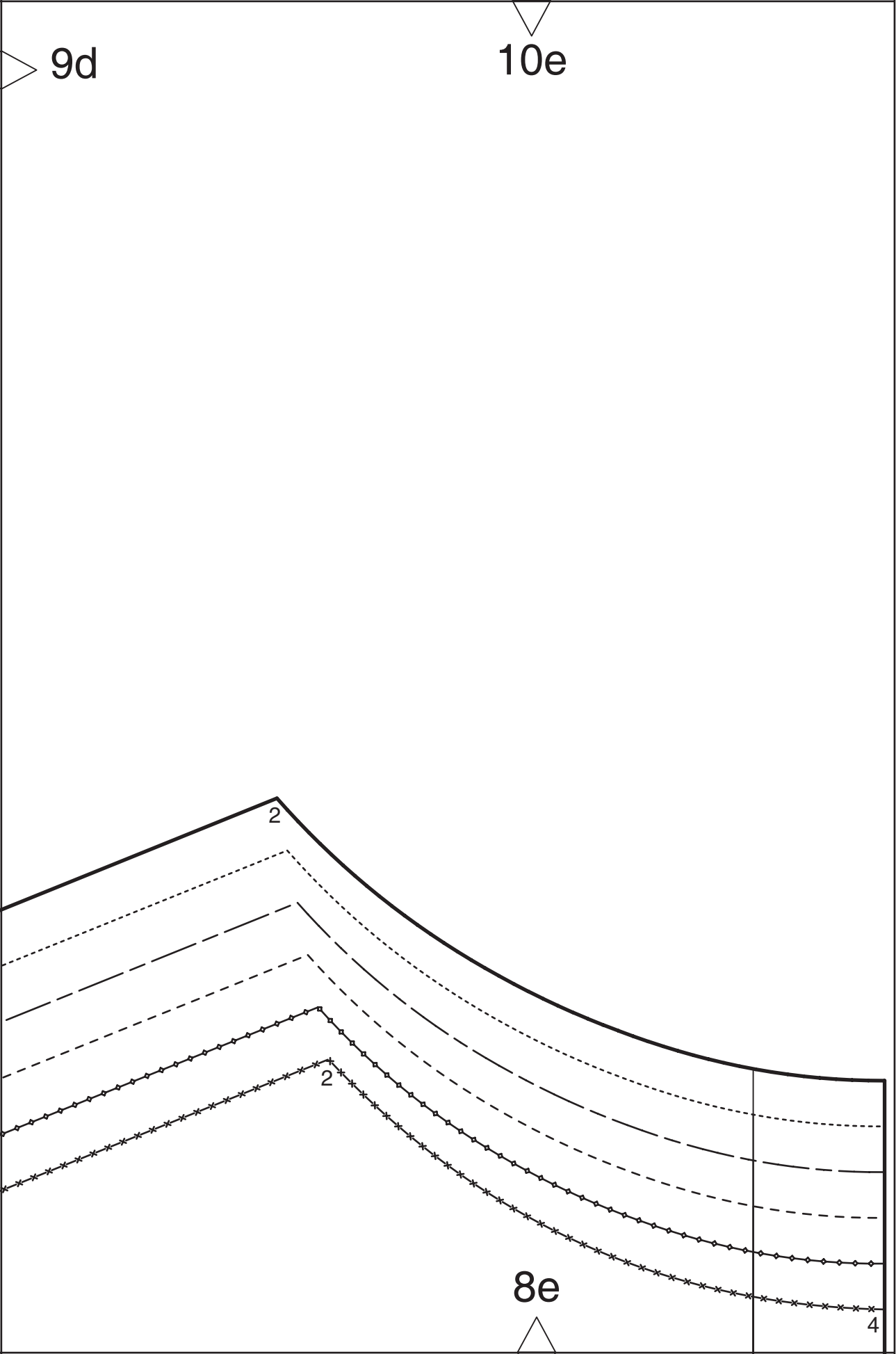

11a

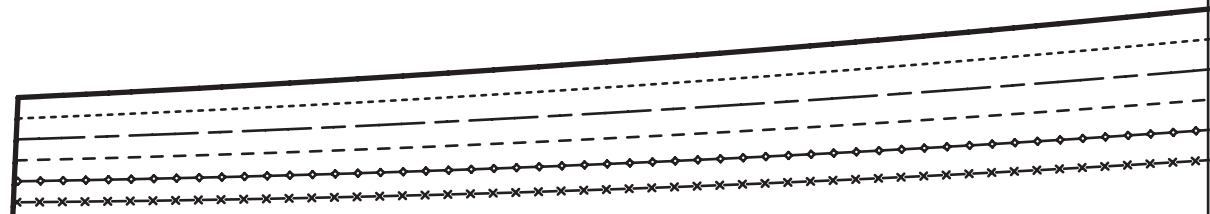

106
, 107

10a



11a

11b

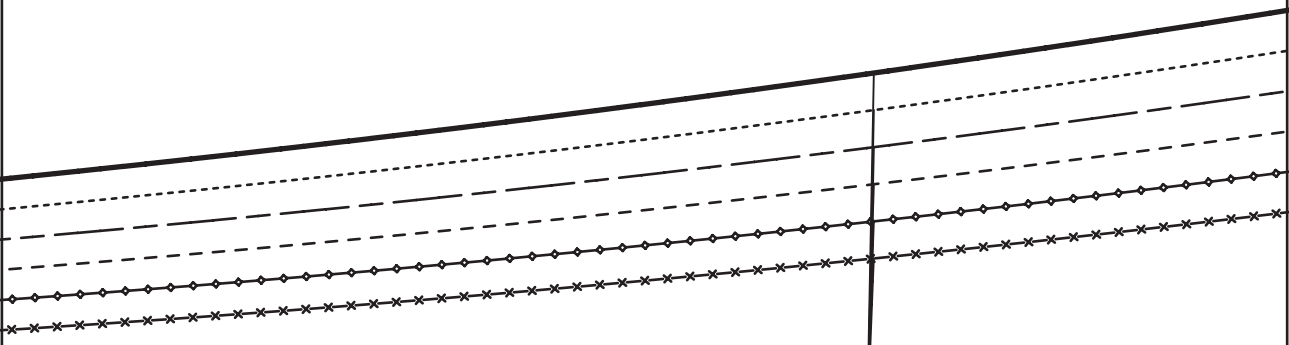

105

10b



