



#MoodLydiaPattern



Print only this page first to check accuracy.
 The Mood square above should measure 2 inches. Print "actual size" in "portrait" mode (not auto center). Formatted for both US Letter & A4 paper sizes.

**Formatted for both
 US Letter & A4 Paper**

Trimless Option: This is the fastest! No trimming needed! Place left-side margins over right-side margins, overlapping dashed lines and dots. In the same fashion, top margins will overlap bottom margins. Slight unprinted gaps are normal for this method.

Trimmed Option: This removes any unprinted gaps. Trim along the top and right margins at the dashed lines. Overlap the trimmed margins to the untrimmed margins, matching dashed lines and dots.

Tip! Build rows first, then join the rows together as you go.

"The Lydia Loungewear Set"

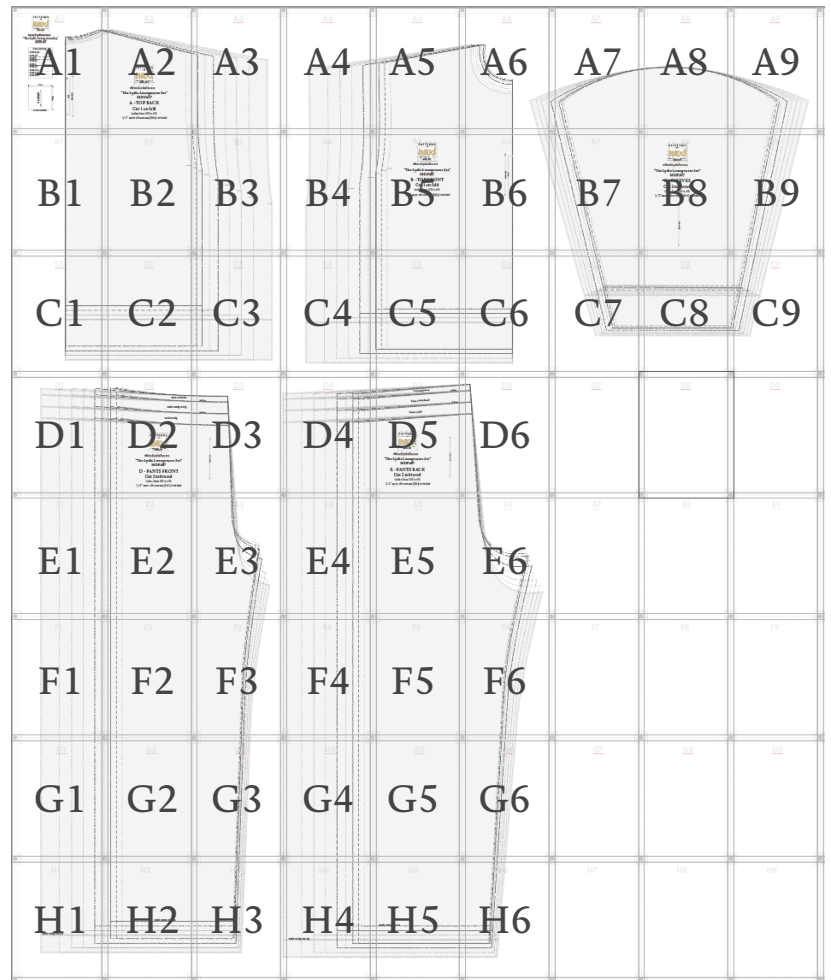
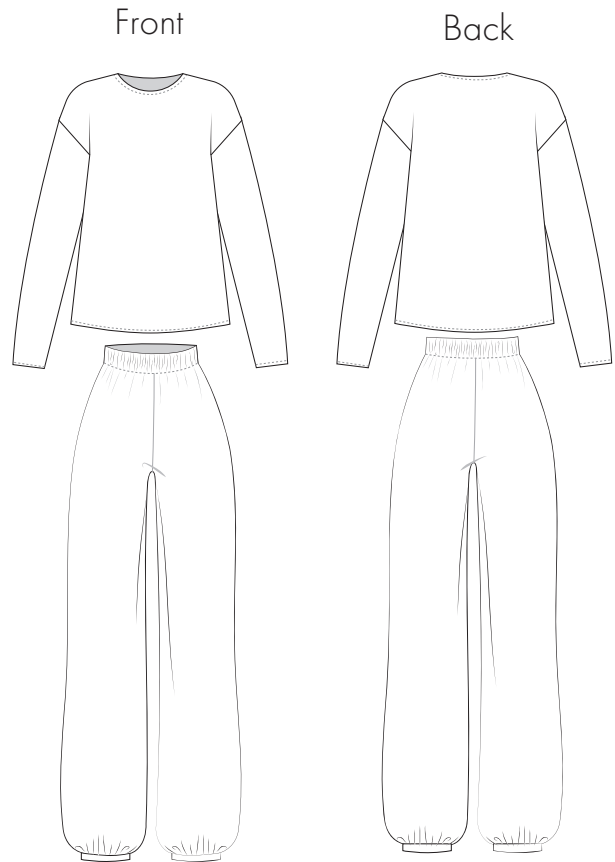



MDF407 - "The Lydia Loungewear Set"

Ladies Sizes XXS to 4XL

BODY MEASUREMENTS - IN INCHES (Chart 1)

SIZE	XXS	XS	S	M	L	XL	2XL	3XL	4XL
BUST	31	31.5 - 33	33.5 - 35	35.5 - 37.5	38 - 40.5	41 - 44.5	45 - 48.5	49 - 52.75	53 - 59.5
WAIST	23	23.5 - 25	25.5 - 27	27.5 - 29.5	30 - 32.5	33 - 36.5	37 - 40.5	41 - 44.75	45 - 51.5
HIPS	34	34.5 - 36	36.5 - 38	38.5 - 40.5	41 - 43.5	44 - 47.5	48 - 51.5	52 - 56	56.5 - 63.5

APPROXIMATE FINISHED GARMENT MEASUREMENTS - IN INCHES (Chart 2)

SIZE	XXS	XS	S	M	L	XL	2XL	3XL	4XL
BUST	41.5	43.5	45.5	48	51	55	59	63.25	70
WAIST*	33	35	37	39.5	42.5	46.5	50.5	54.75	61.5
HIPS	35	37	39	41.5	44.5	48.5	52.5	57	64.5

*Before adding elastic (Pants)

Size guide is based on the suggested design & wearing ease for this style. You can also choose the size according to your desired finished garment measurements, blending between sizes as needed. For best results, sew a test garment in a similar fabric to adjust your pattern.

Recommended Fabric: Cashmere wool, Angora Wool Knit, Flannel, French Terry.

We love creating these free patterns for the community and we want to keep them free! In return, we hope you check out MoodFabrics.com for your next project!

Want to use one of our patterns to make a garment to sell? Our patterns are royalty-free! We just ask that you credit us with:
MoodSewciety.com
or
MoodFabrics.com
in your product description.

FOR SEWING INSTRUCTIONS AND MORE INFORMATION:

Scan the QR code or visit MoodSewciety.com and search "MDF407"



1/2" seam allowances (SA's) included unless stated otherwise.

REMEMBER TO SHARE YOUR MADE WITH MOOD LOOK!

Tag us and use:

#MoodLydiaPattern

for a shot at being featured on our social media

@mood.fabrics

@moodfabrics

@Mood_Fabrics

@moodfabrics

@moodfabrics



“The Lydia Loungewear Set”

Ladies Sizes XXS to 4XL

A	TOP BACK FABRIC - CUT 1 ON FOLD
B	TOP FRONT FABRIC - CUT 1 ON FOLD
C	SLEEVES FABRIC - CUT 2 MIRRORED
D	PANTS FRONT FABRIC - CUT 2 MIRRORED
E	PANTS BACK LINING - CUT 2 MIRRORED

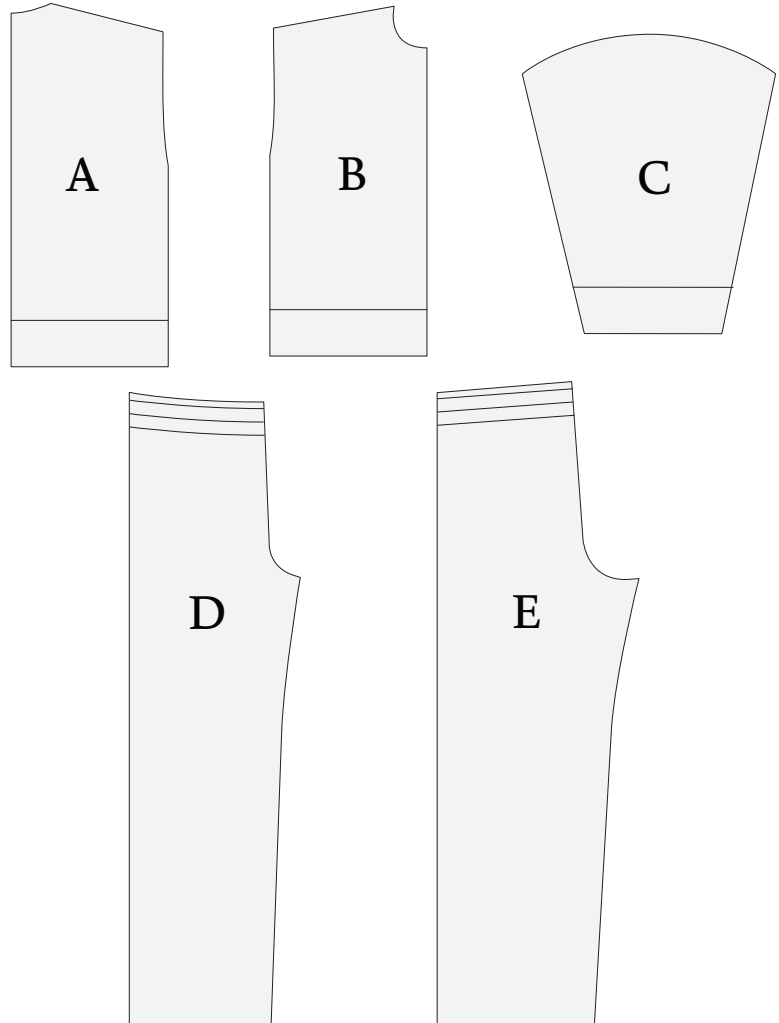

Size Line Key	
SIZE XXS	-----
SIZE XS	- - - - -
SIZE S
SIZE M	_____
SIZE L
SIZE XL	-----
SIZE 2XL
SIZE 3XL	-----
SIZE 4XL



#MoodLydiaPattern
“The Lydia Loungewear Set”
MDF407

Size Line Key
SIZE XXS
SIZE XS
SIZE S
SIZE M
SIZE L
SIZE XL
SIZE 2XL
SIZE 3XL
SIZE 4XL

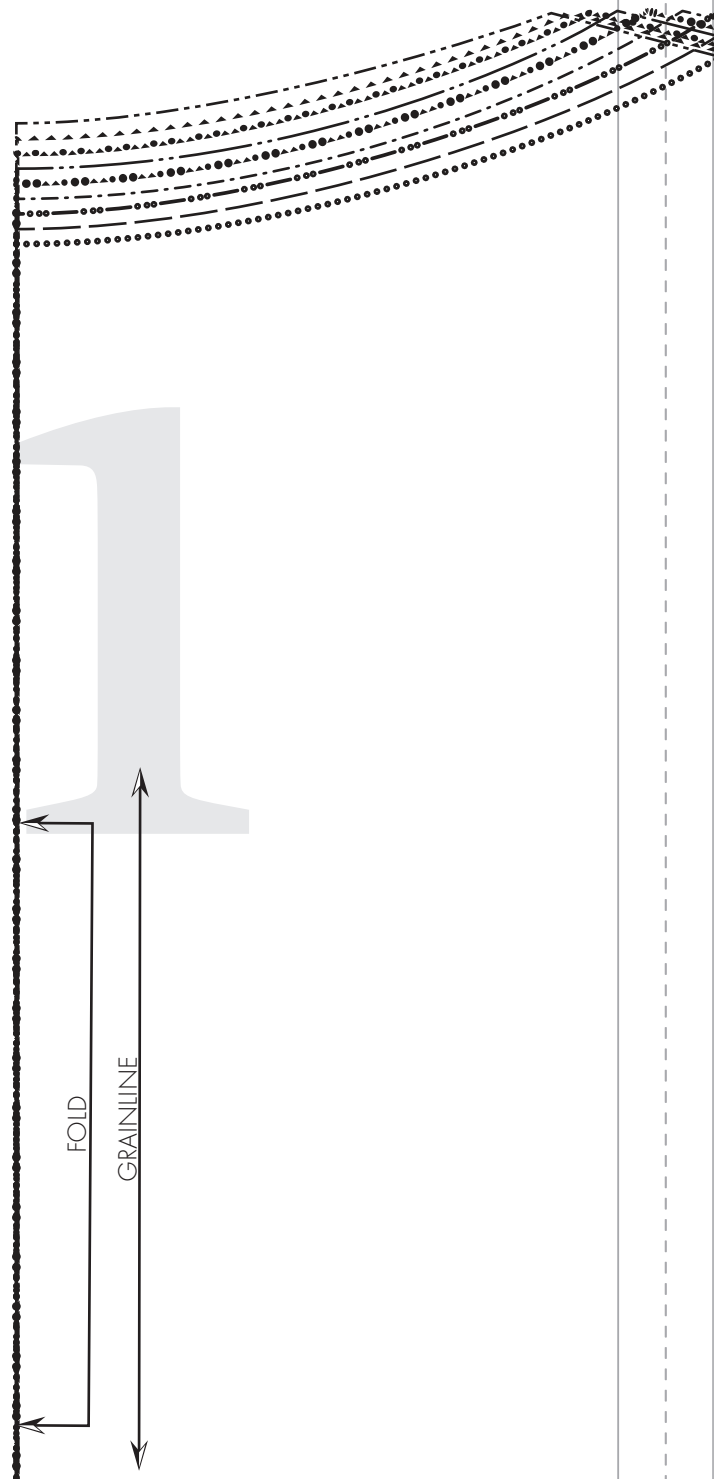
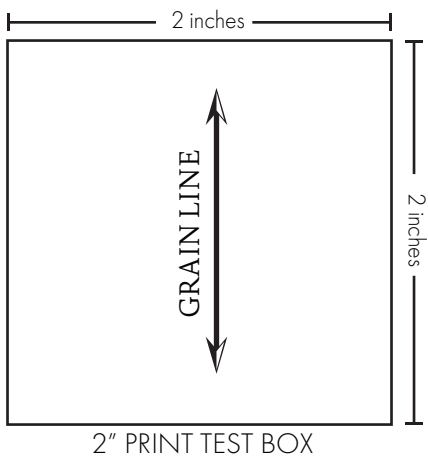



PATTERNS

BY

mood

DESIGNER FABRICS

MDF407

#MoodLydiaPattern

“The Lydia Loungewear Set”
MDF407

A - TOP BACK

Cut 1 on fold

Ladies Sizes XXS to 4XL

1/2" seam allowances (SA's) included

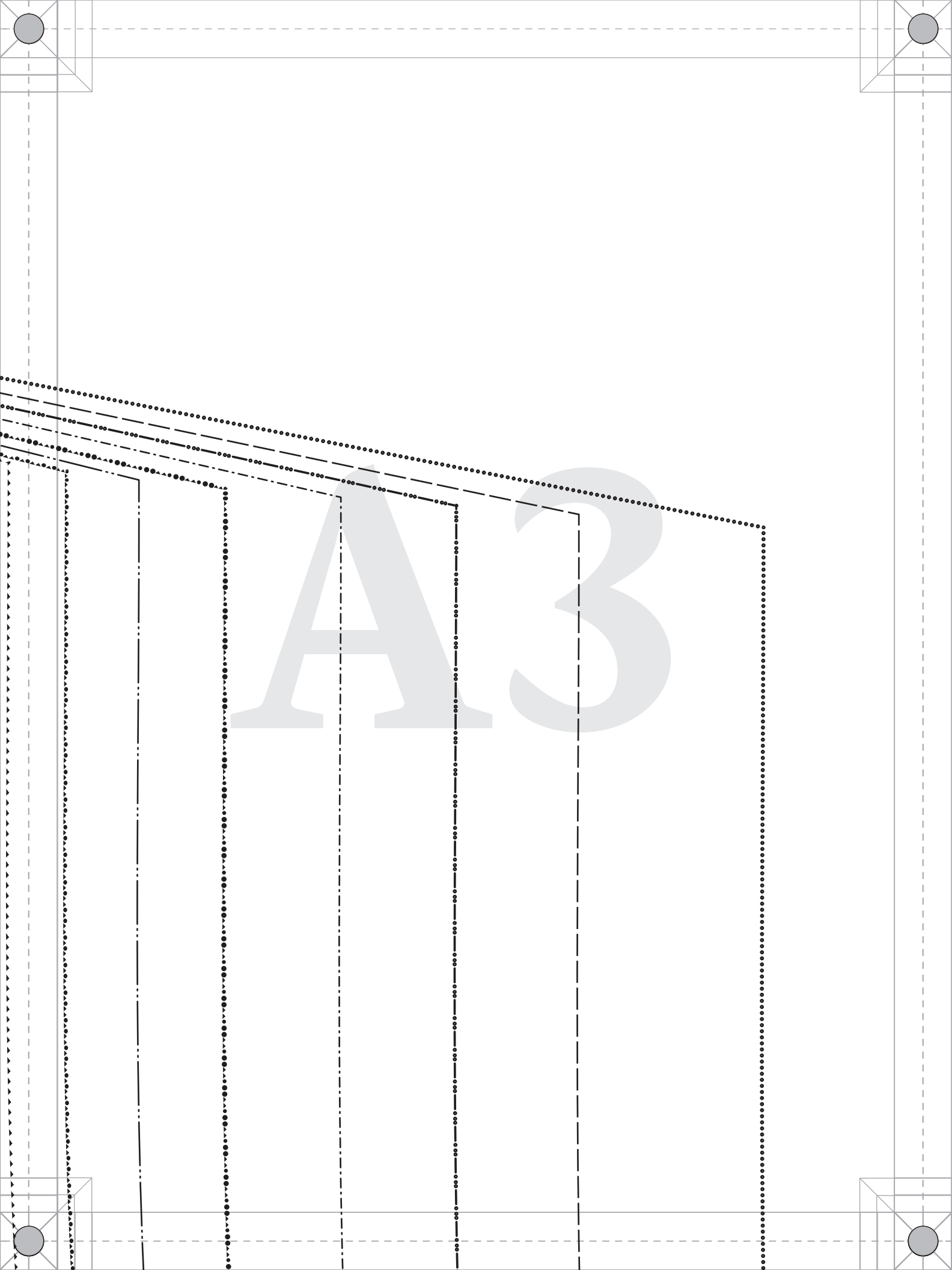

A4

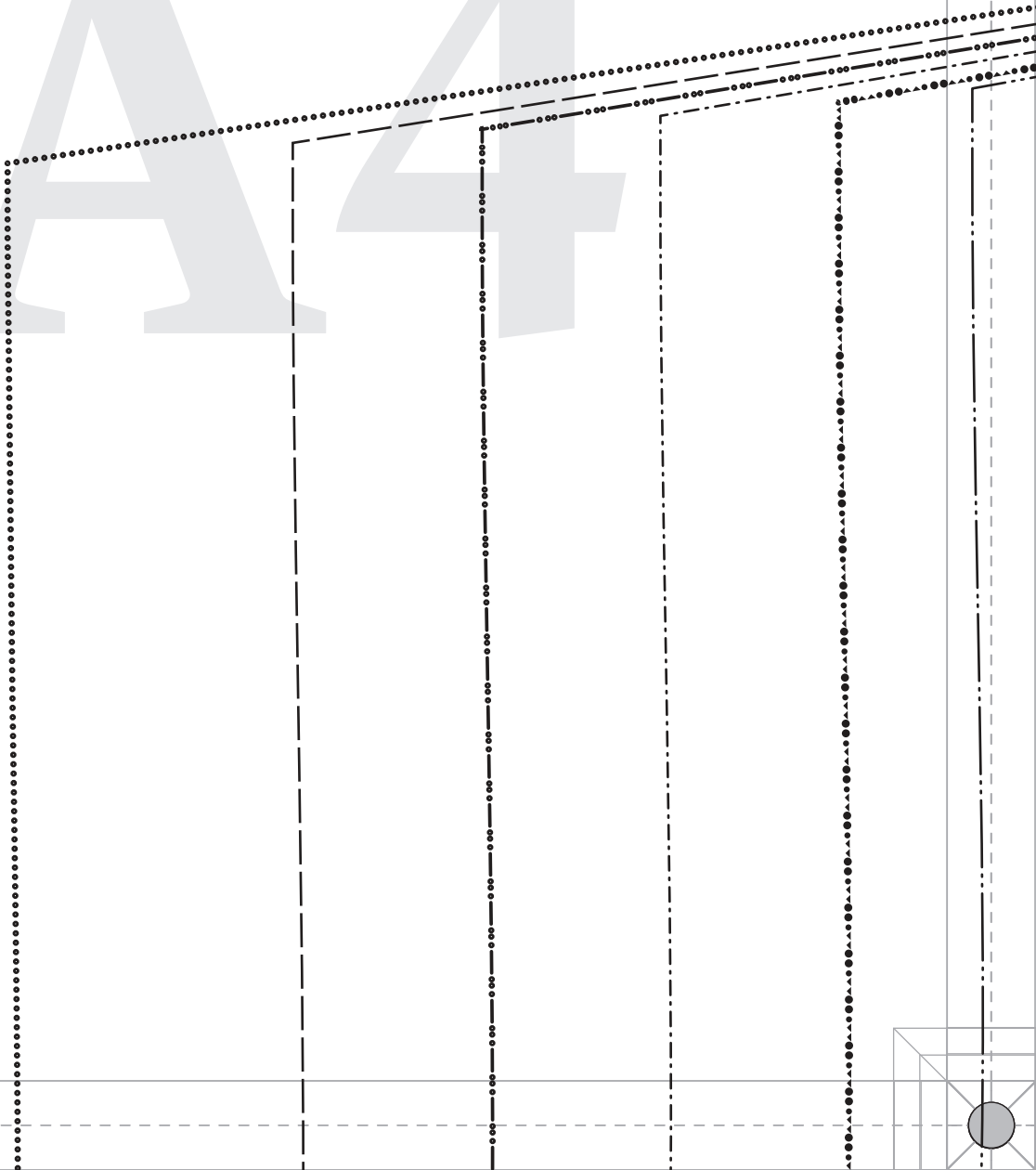

A5

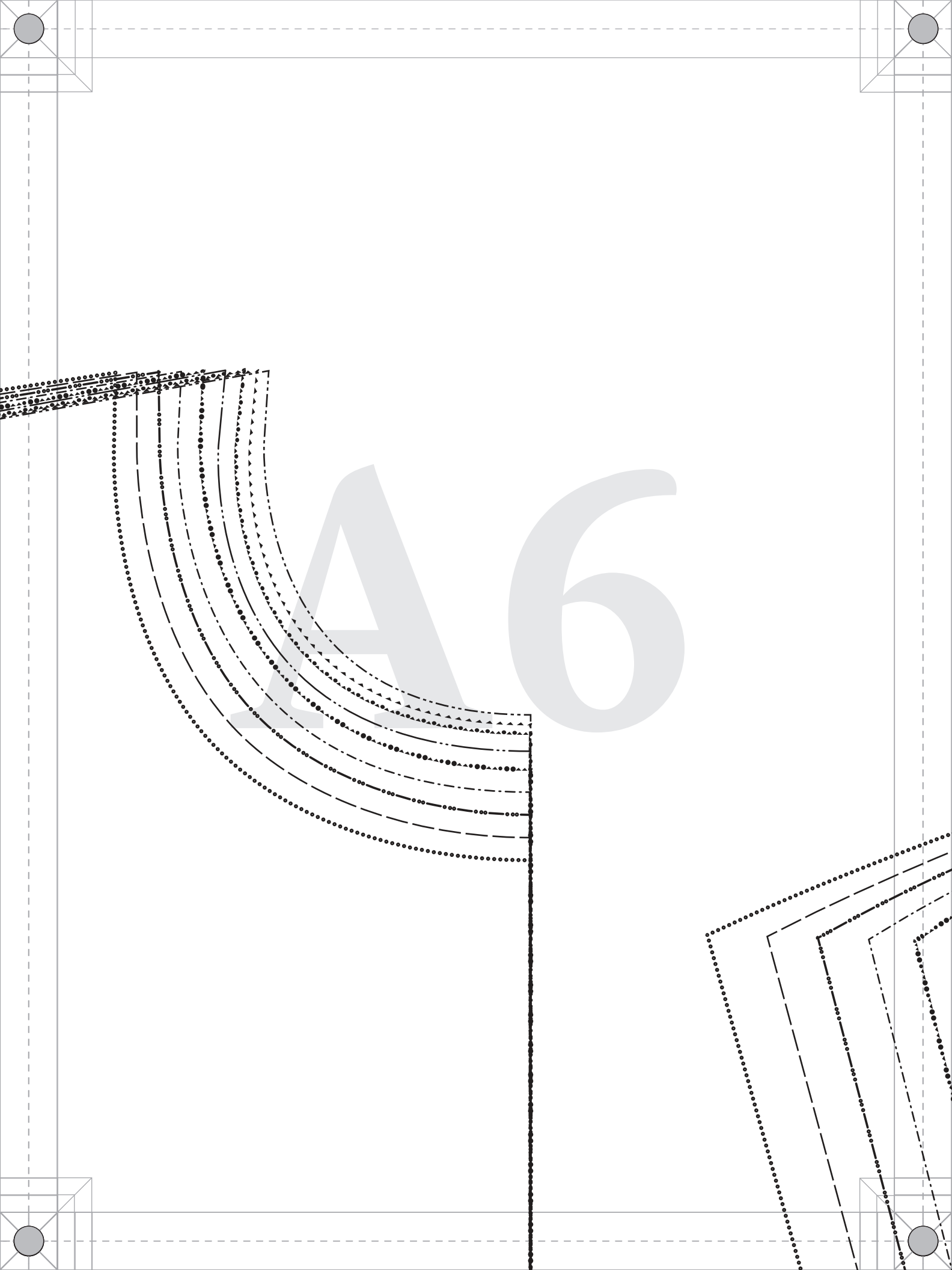

A7

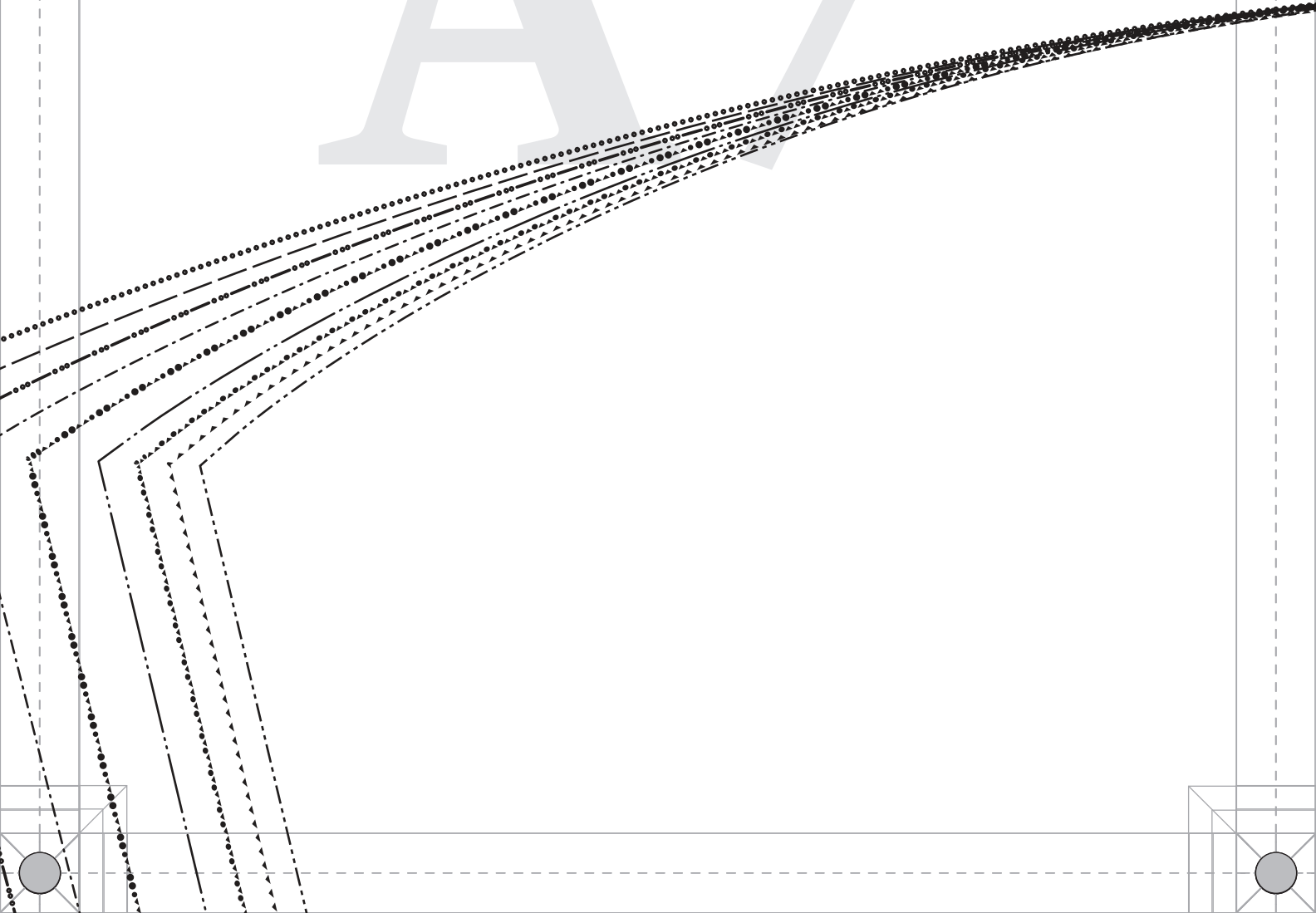

AS

A9

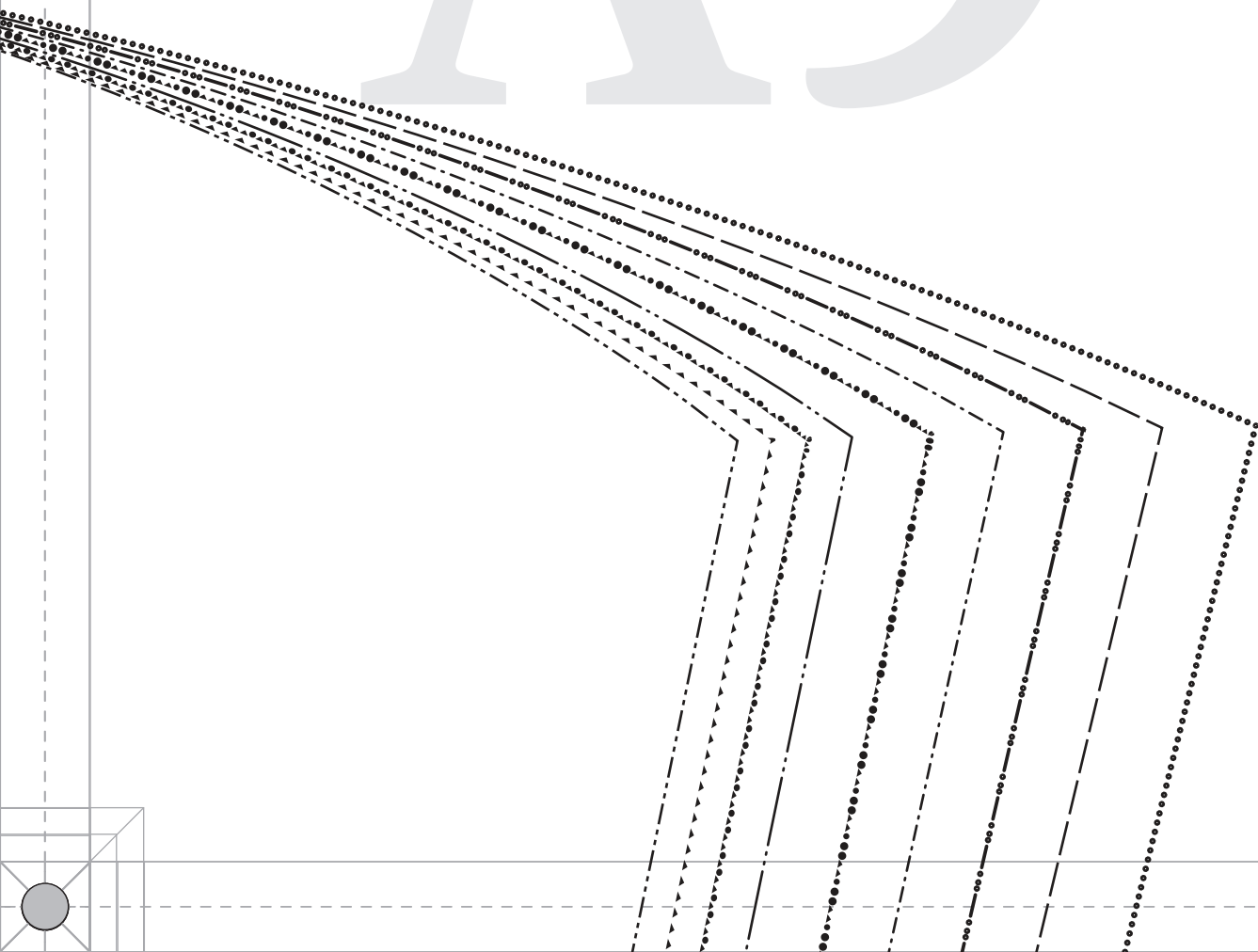

B 1

B2

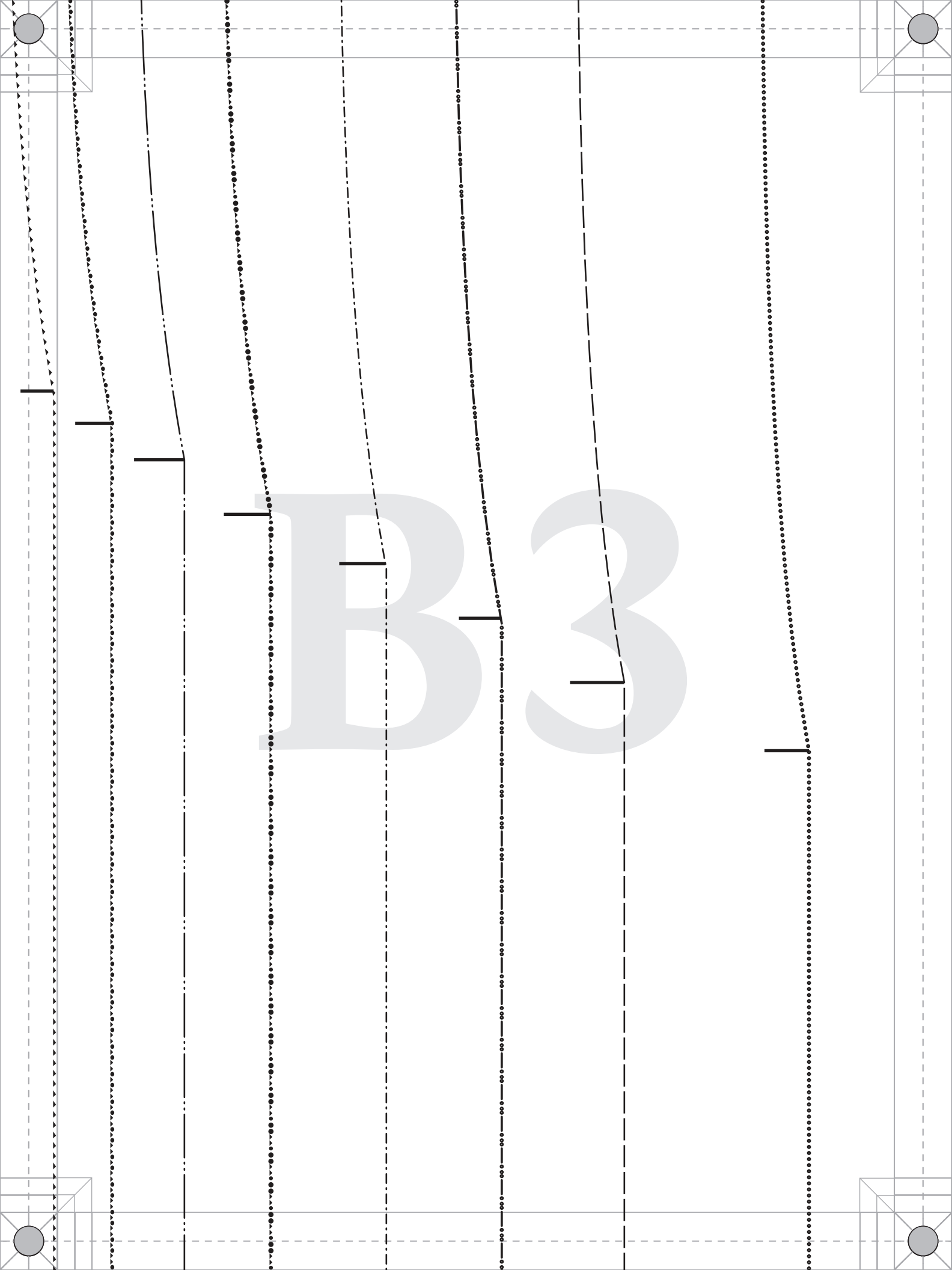

33

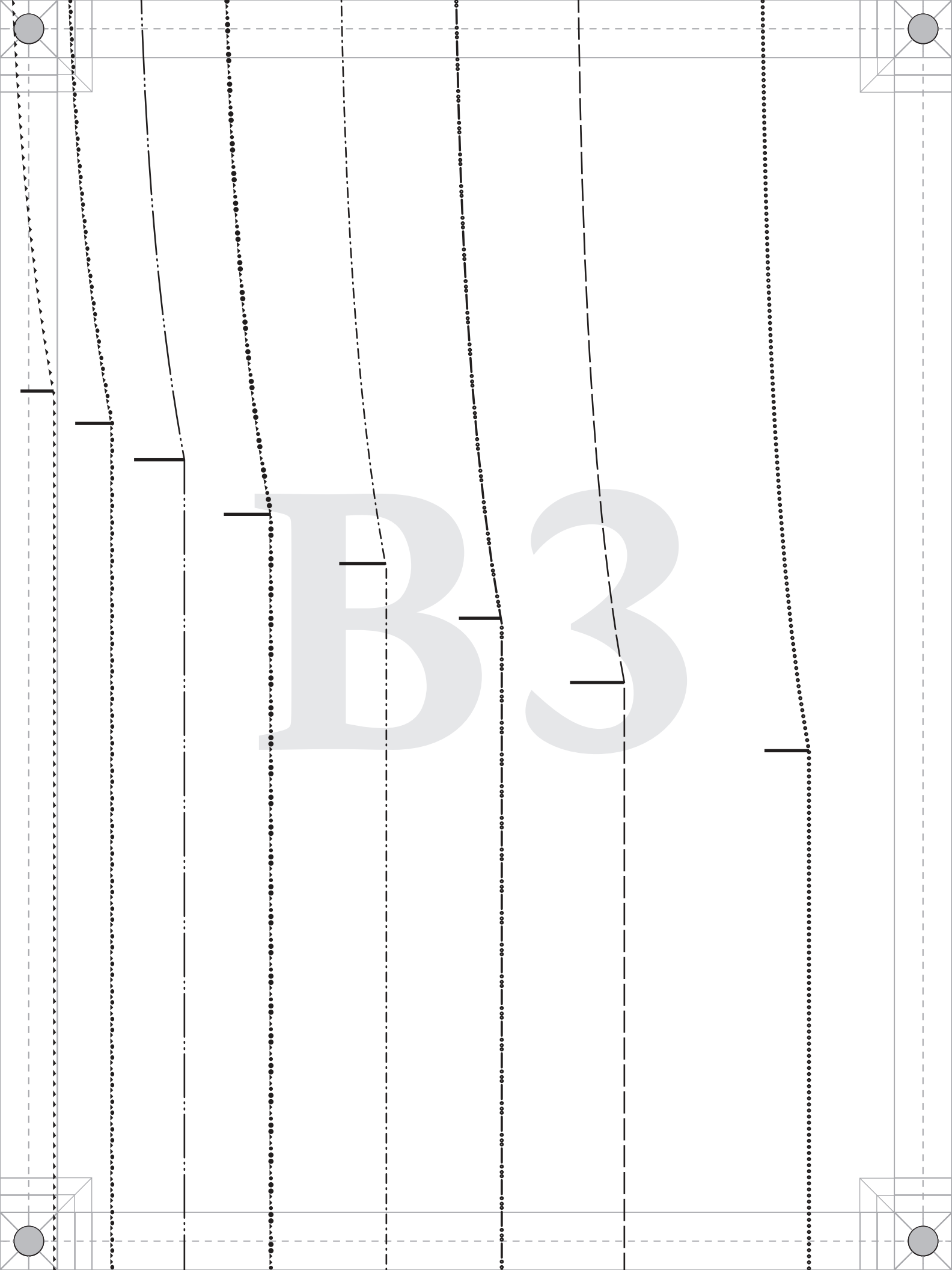

B4



#MoodLydiaPattern

“The Lydia Loungewear Set”
MDF407

B - TOP FRONT

Cut 1 on fold

Ladies Sizes XXS to 4XL

1/2" seam allowances (SA's) included

B6

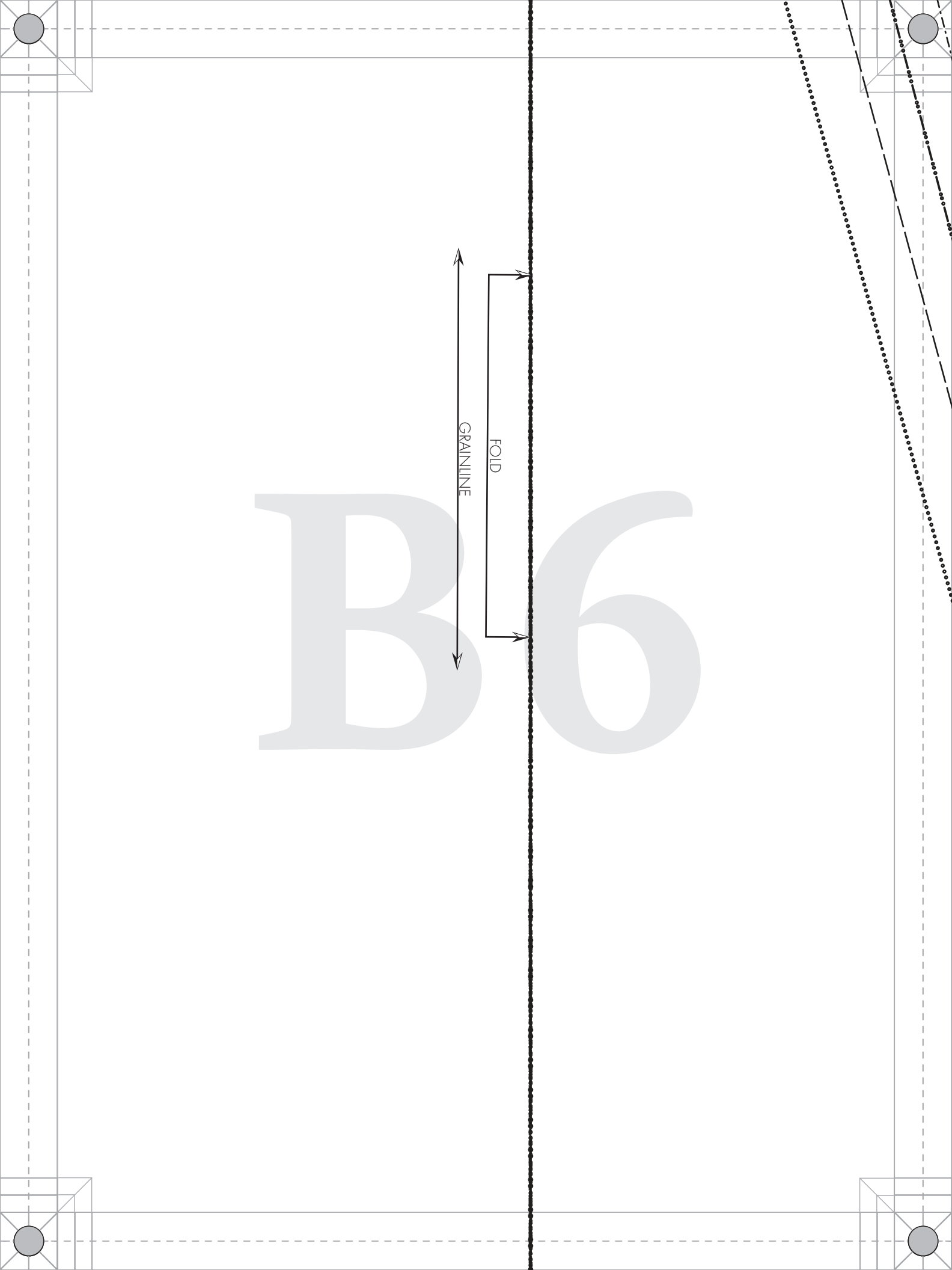

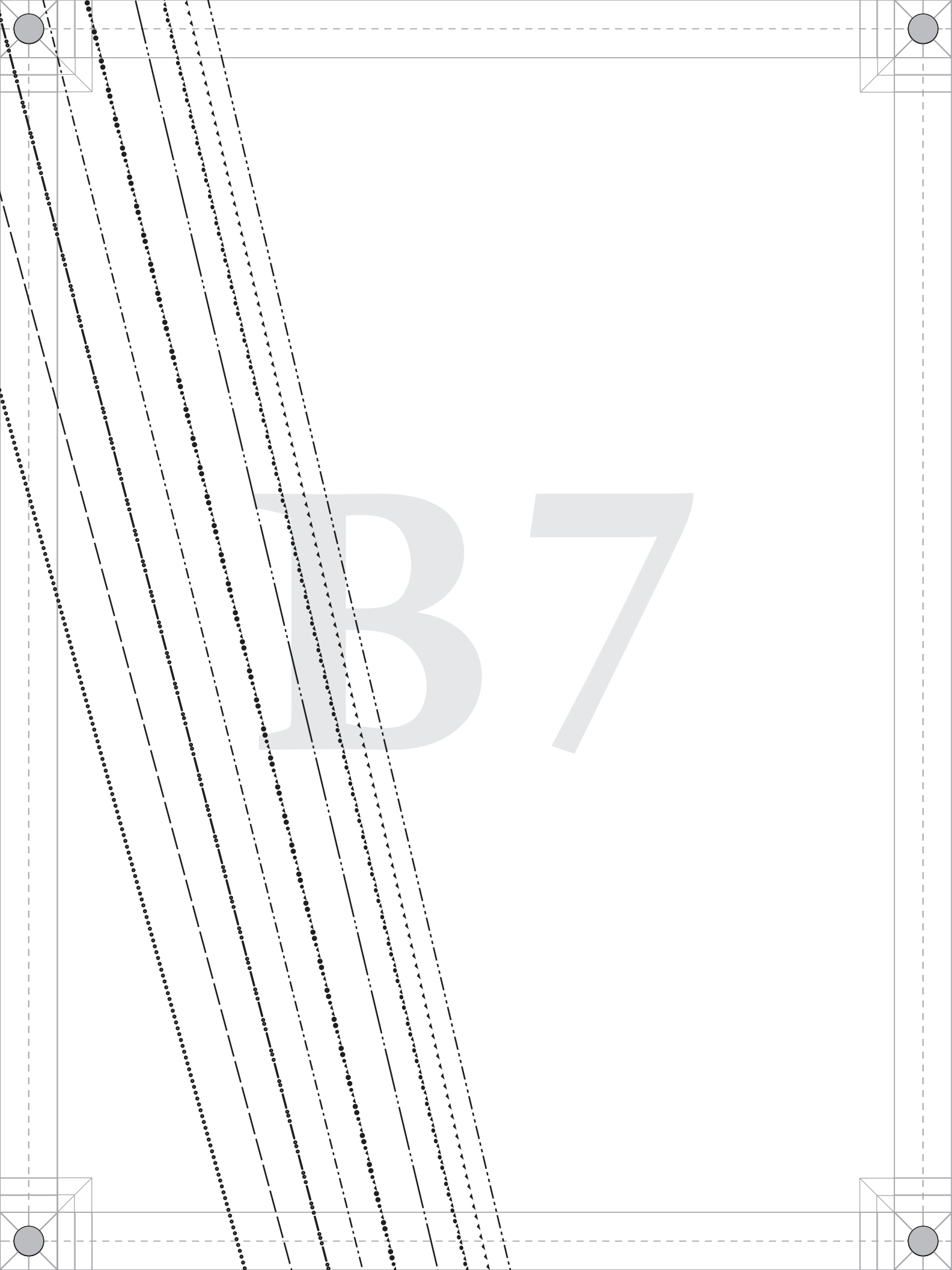



#MoodLydiaPattern

“The Lydia Loungewear Set”
MDF407

C - SLEEVES

Cut 2 mirrored

Ladies Sizes XXS to 4XL

1/2" seam allowances (SA's) included

GRAINLINE

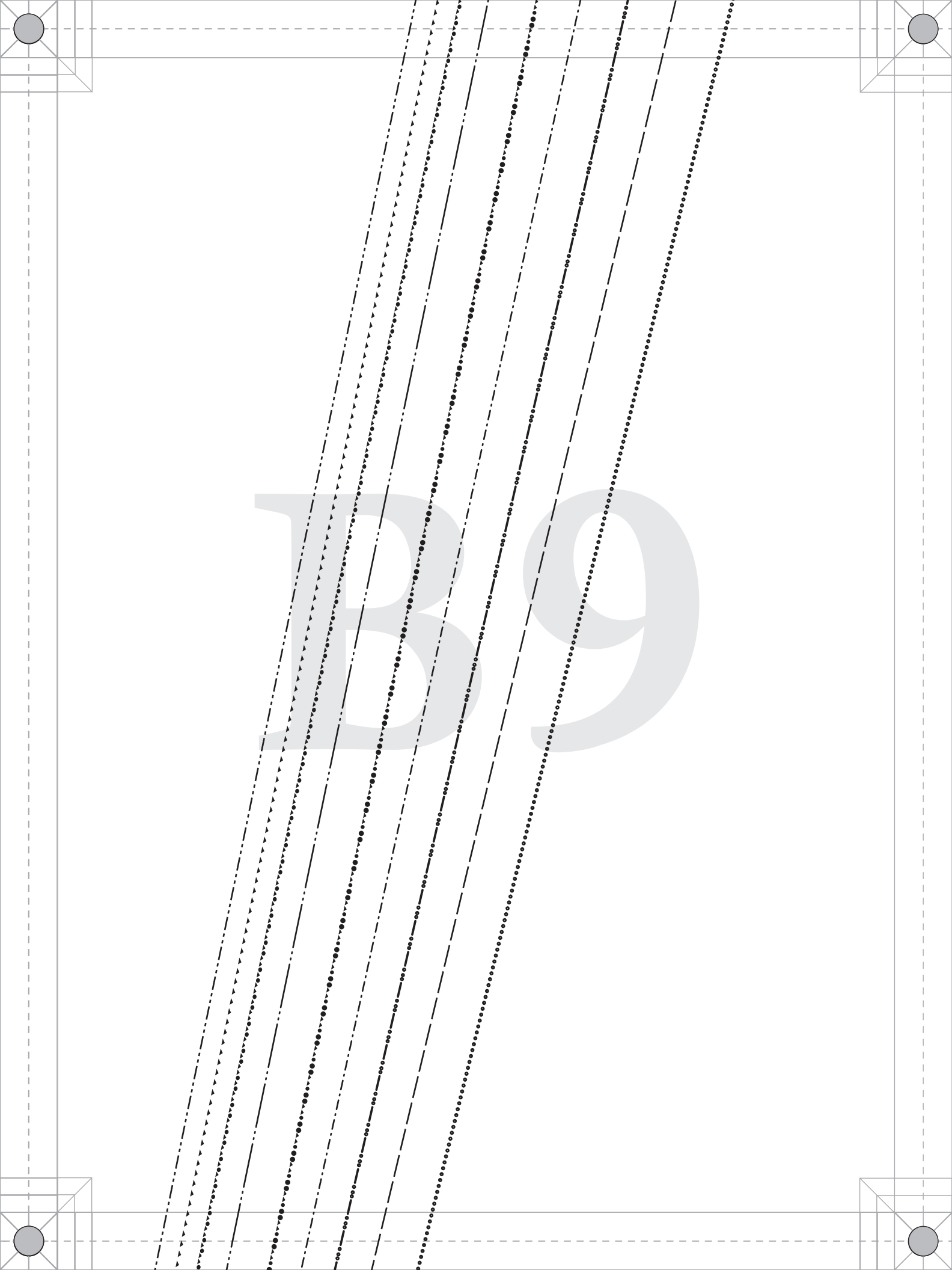

C 1

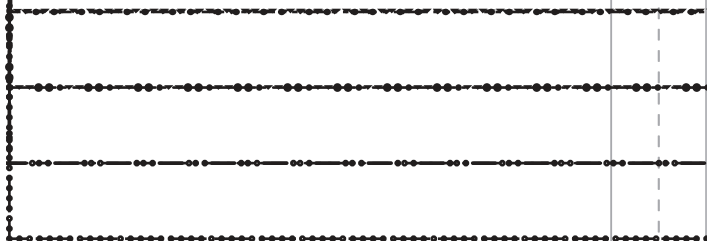

C2

Shorten or Lengthen here

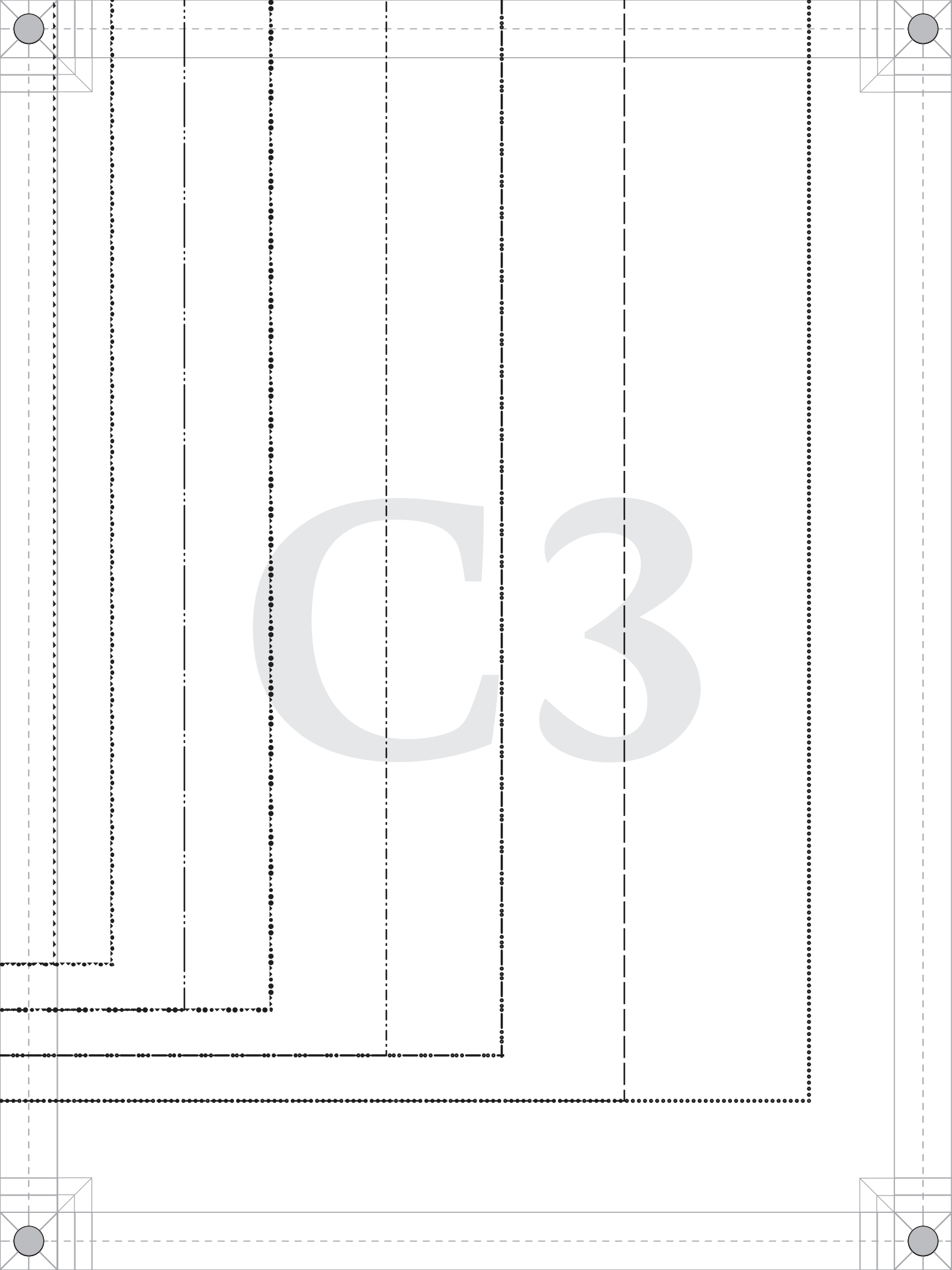

C 3

C4

C5

Shorten or Lengthen here

C6

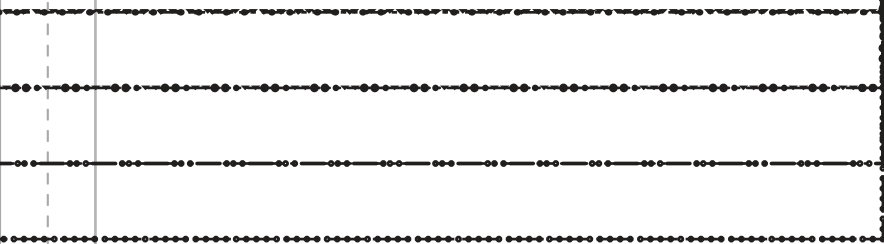

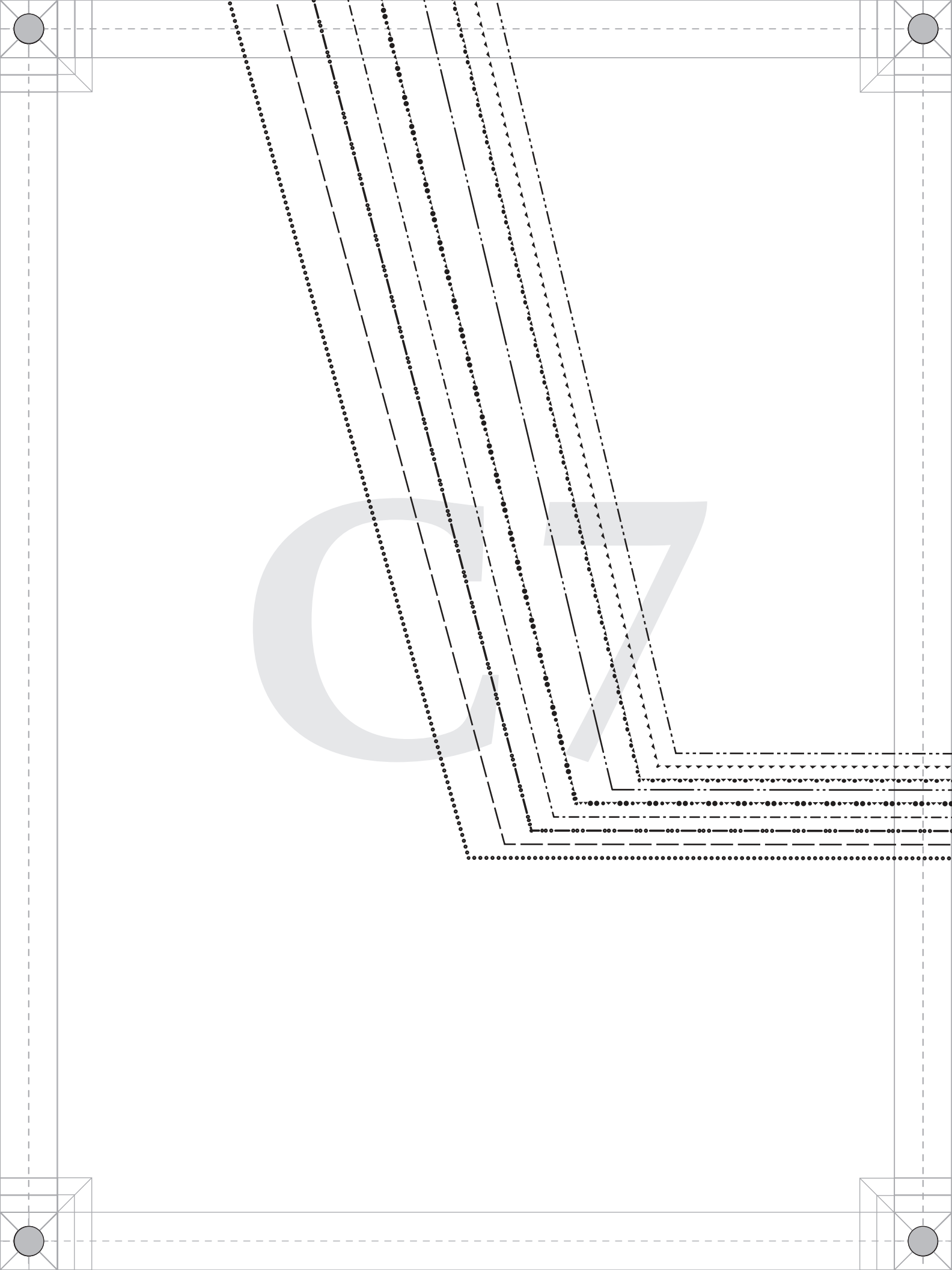

C8

Shorten or Lengthen here

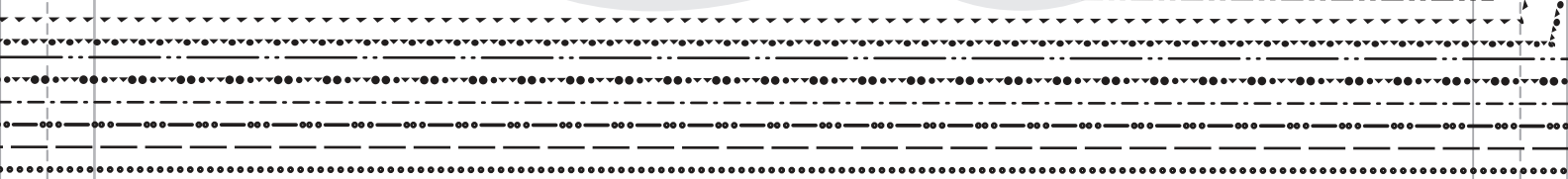

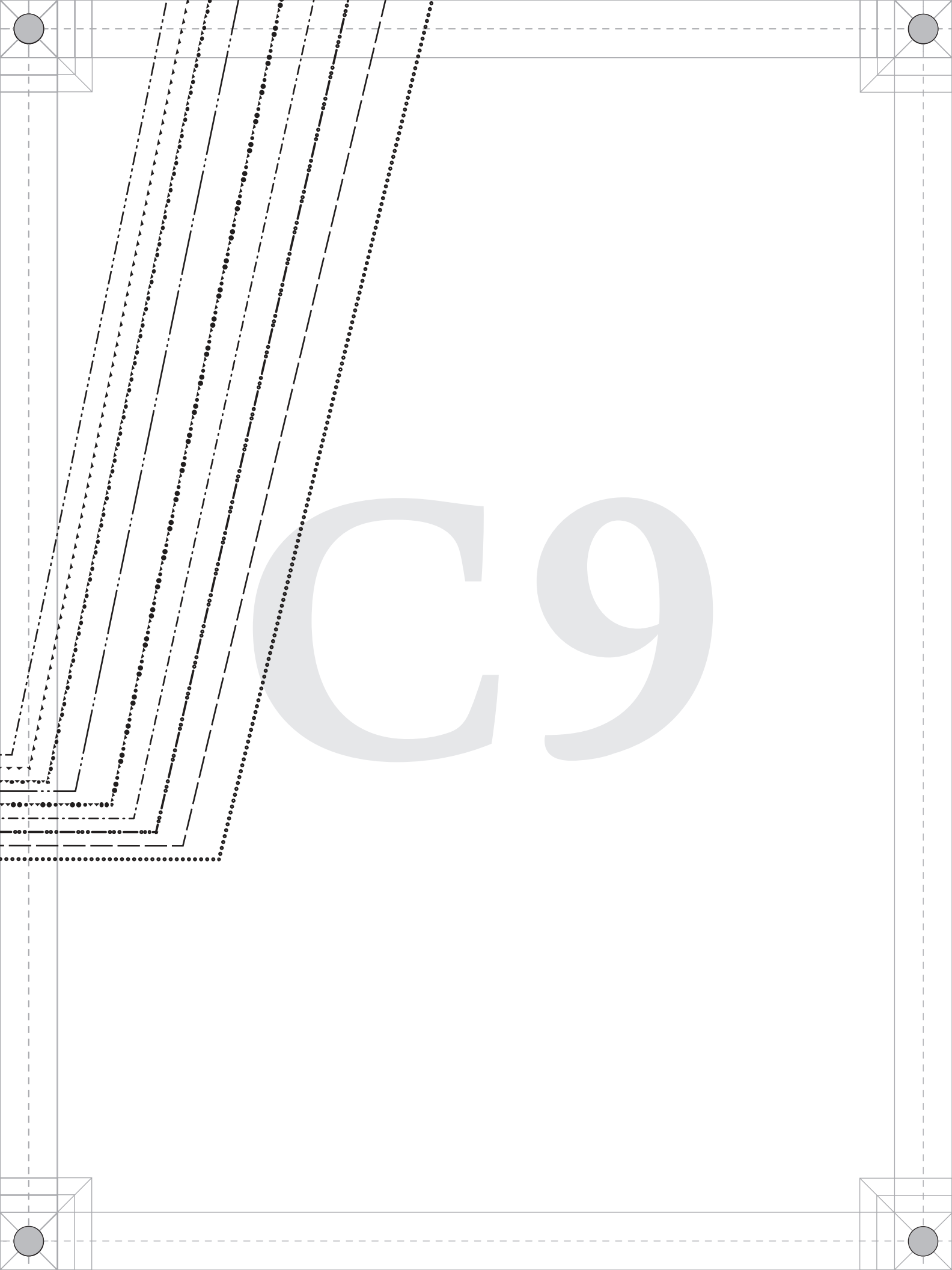

9

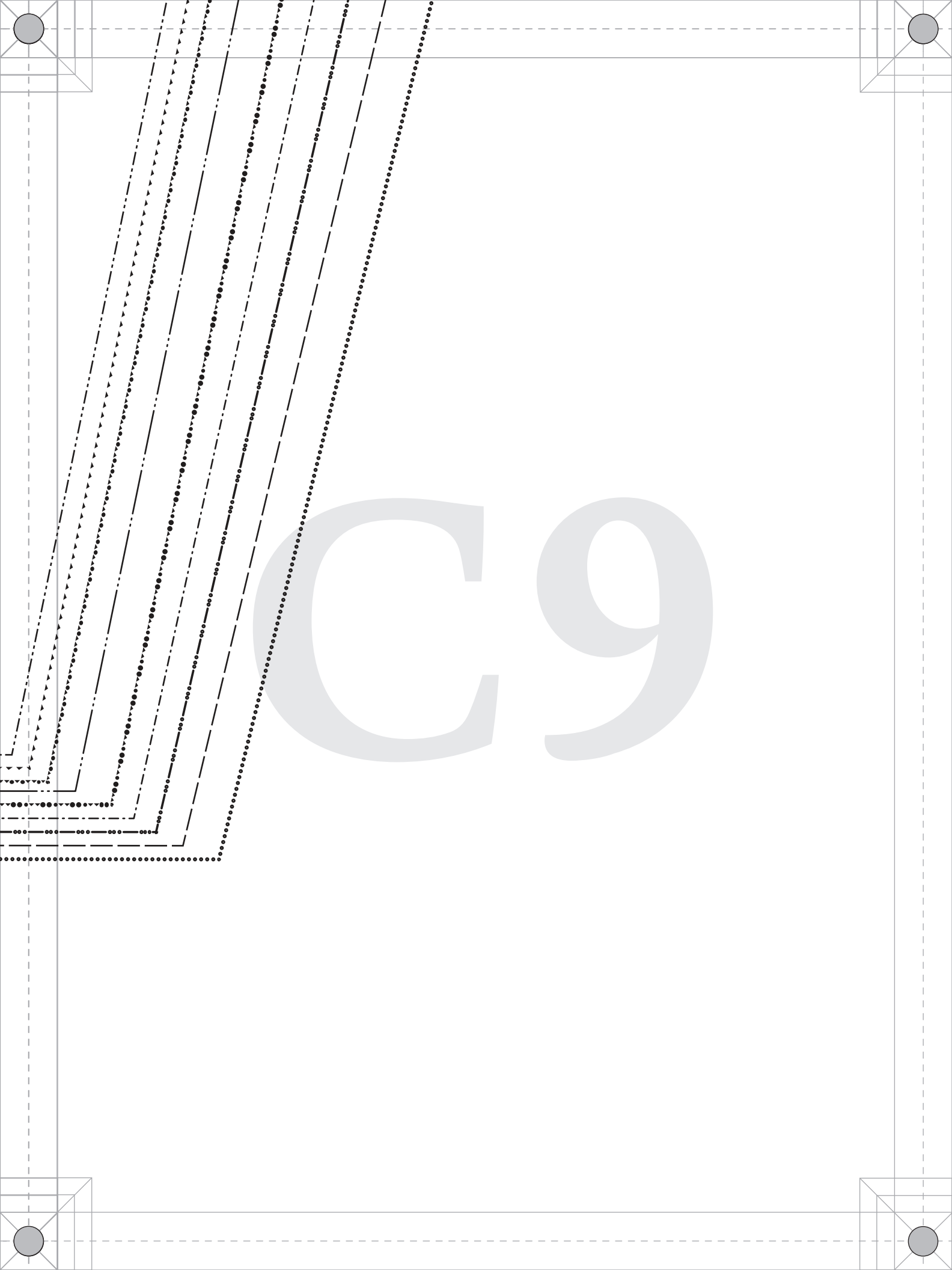

DI



Seam Allowance

Elastic Casing Facing

Elastic Casing

PATTERNS

BY

mood

DESIGNER FABRICS

MDF407

#MoodLydiaPattern

**“The Lydia Loungewear Set”
MDF407**

D - PANTS FRONT

Cut 2 mirrored

Ladies Sizes XXS to 4XL

1/2" seam allowances (SA's) included

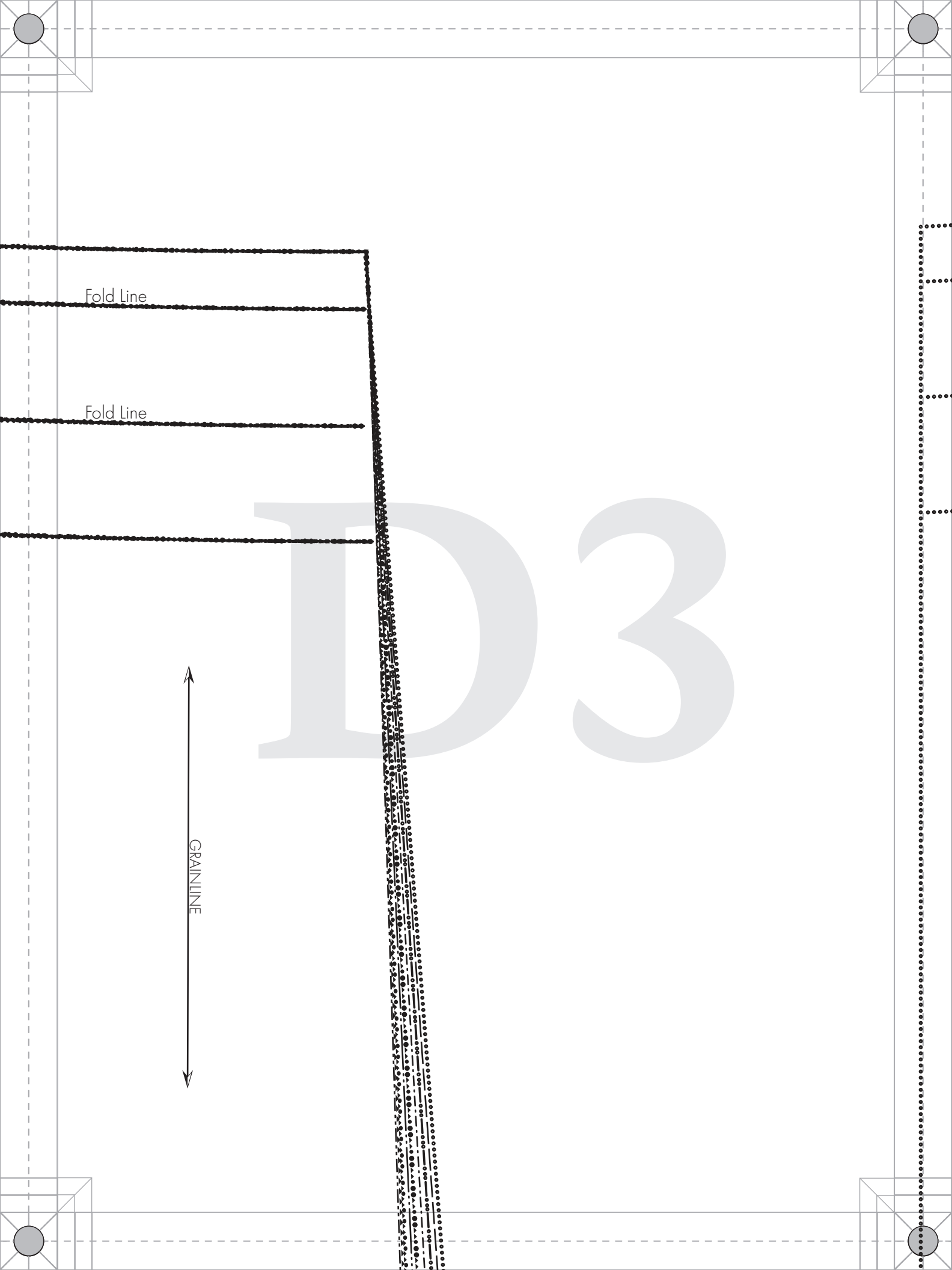

Fold Line

Fold Line

GRAINLINE

D3

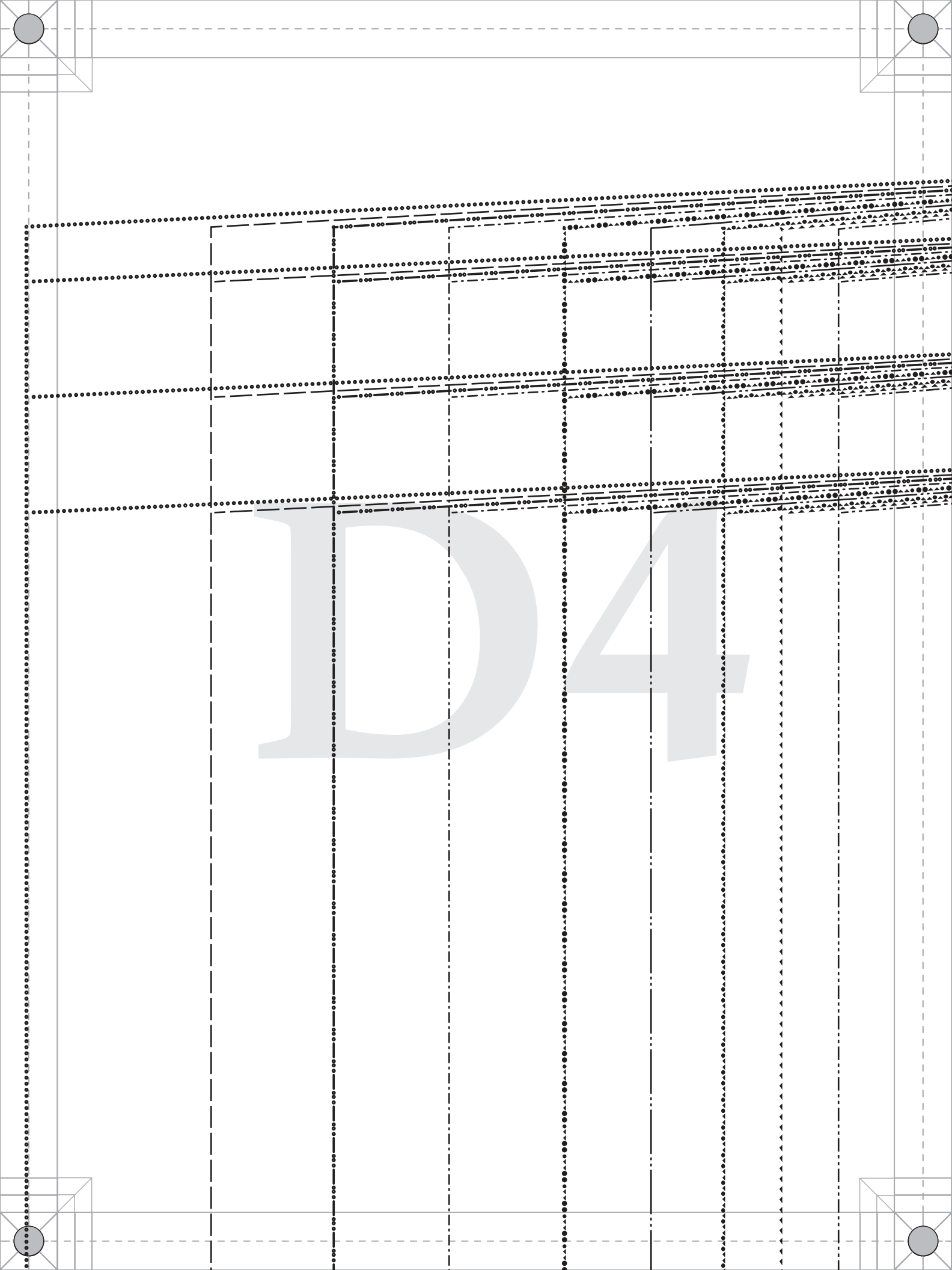

Seam Allowance

Fold Line

Elastic Casing Facing

Fold Line

Elastic Casing



#MoodLydiaPattern

**“The Lydia Loungewear Set”
MDF407**

E - PANTS BACK

Cut 2 mirrored

Ladies Sizes XXS to 4XL

1/2" seam allowances (SA's) included



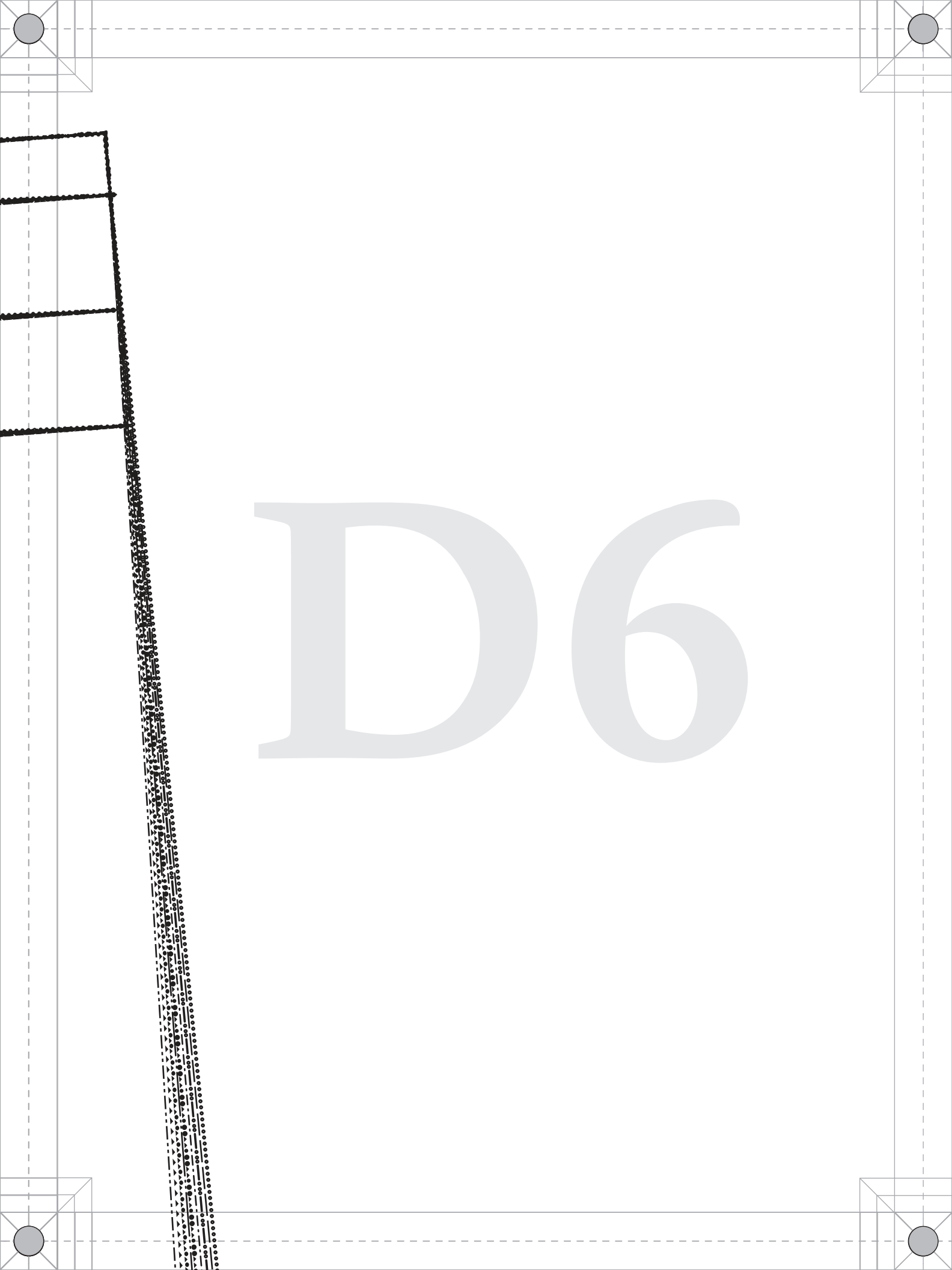

D6

E 1

E2

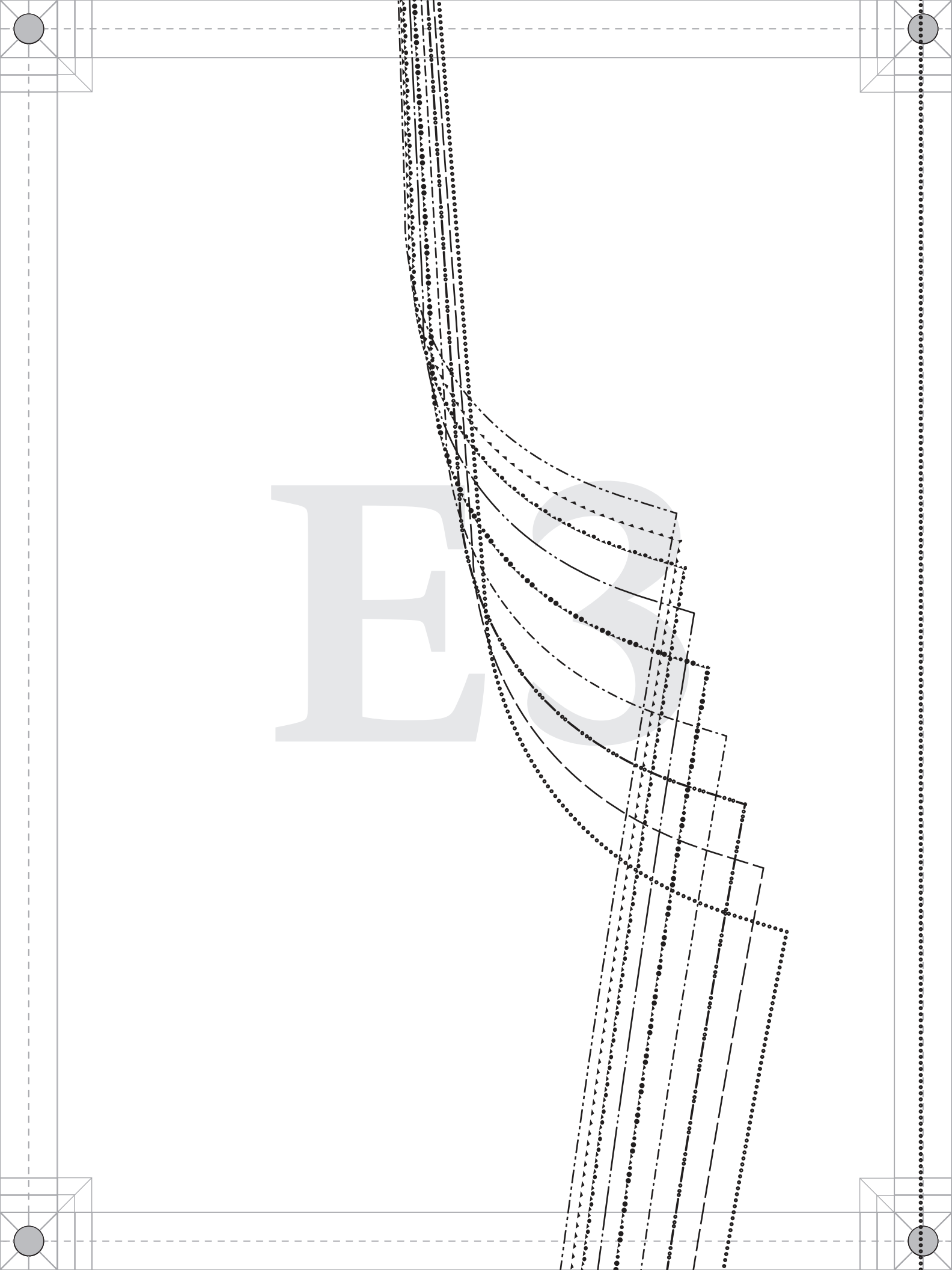

E4

E5

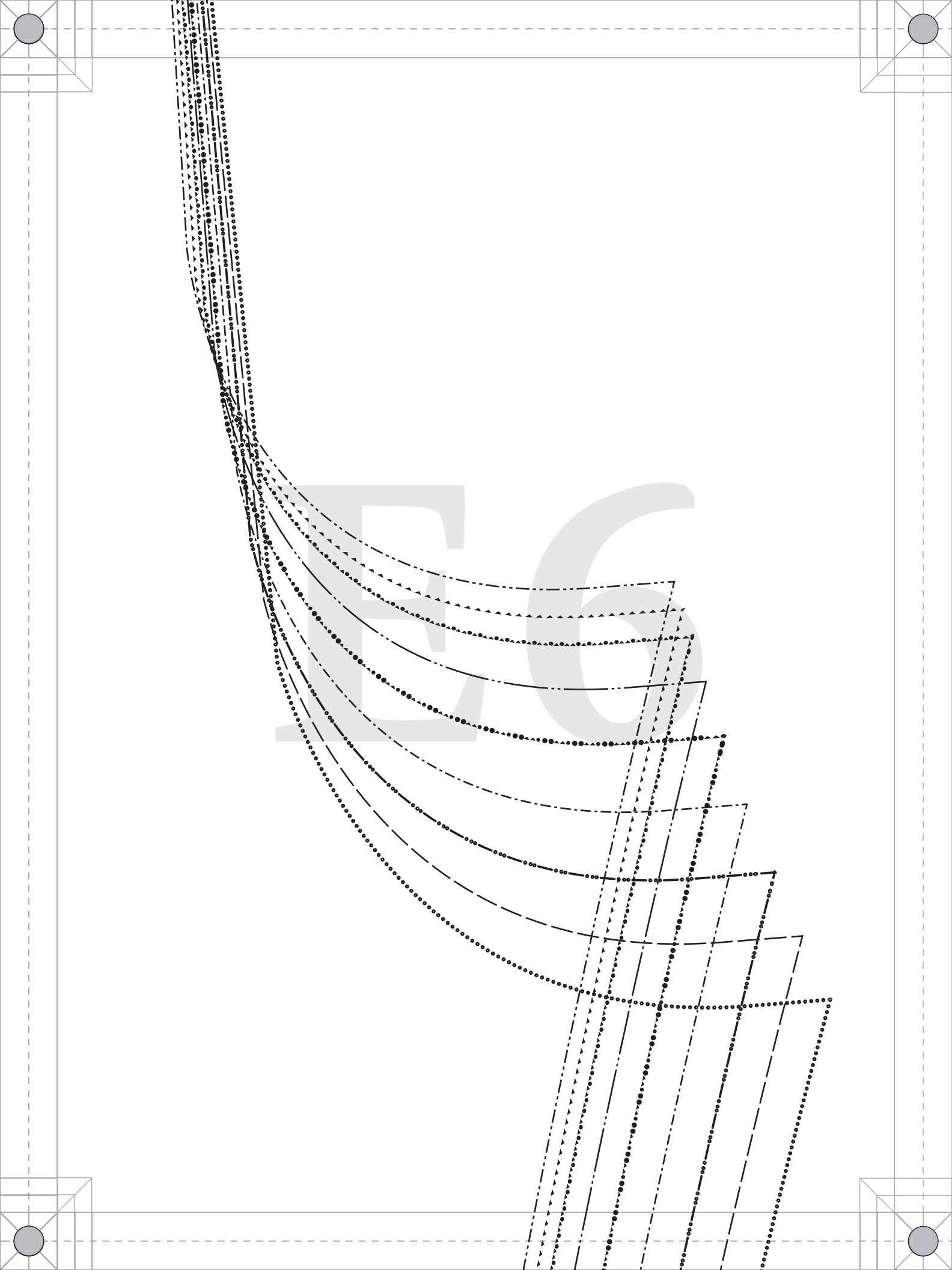

FEI

F2

FE

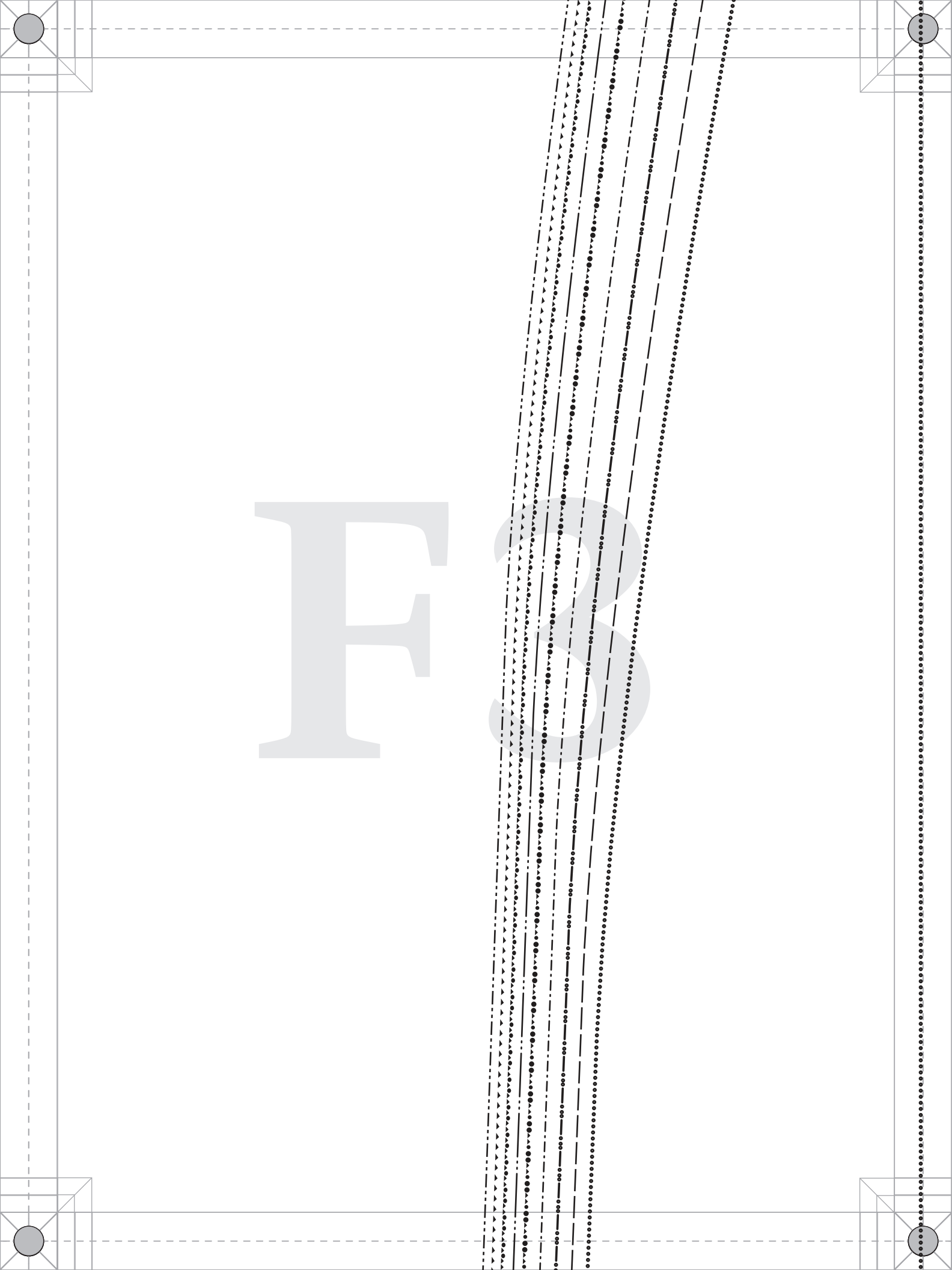
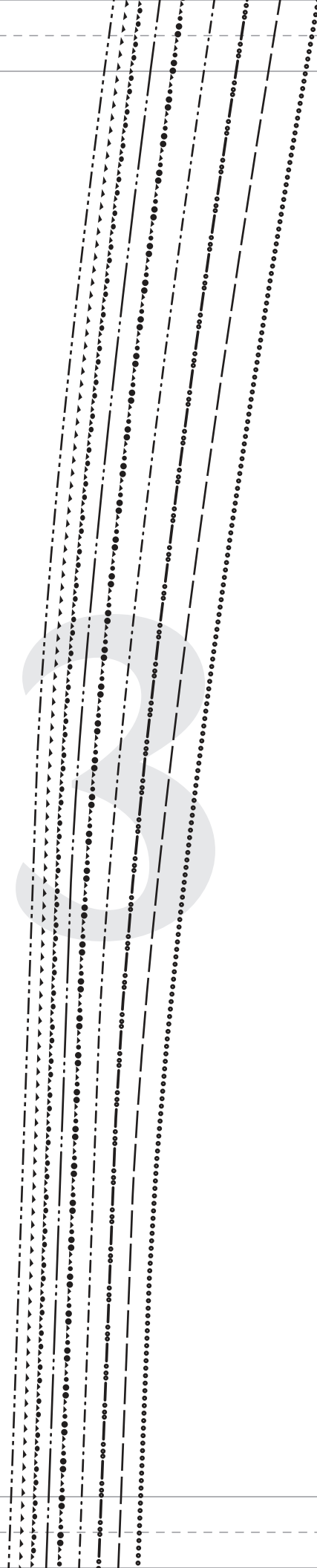
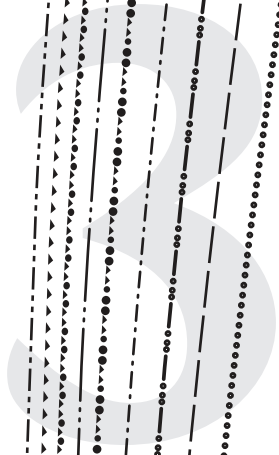

E4

F5

FE6

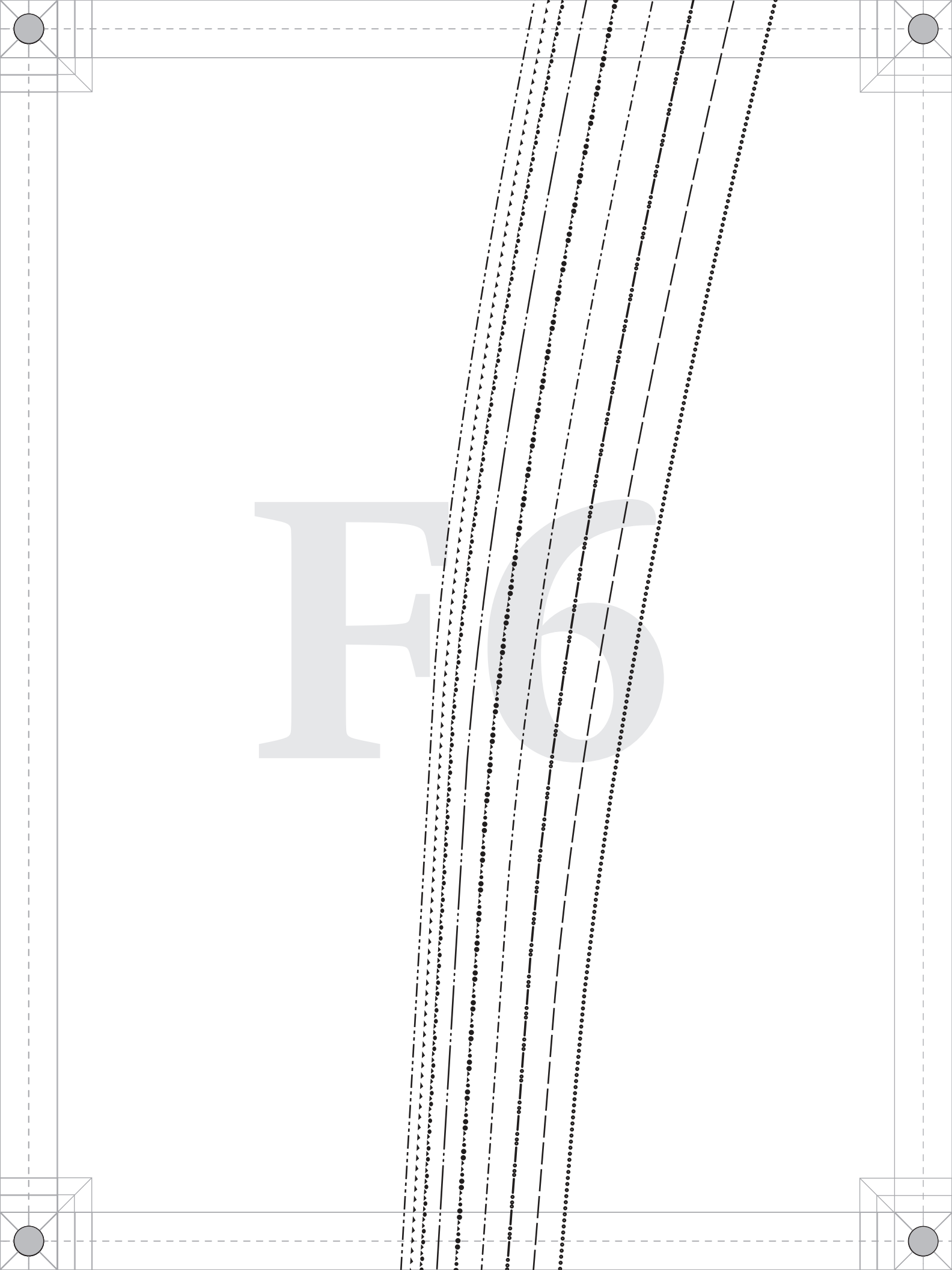

G 1

G2

GG3

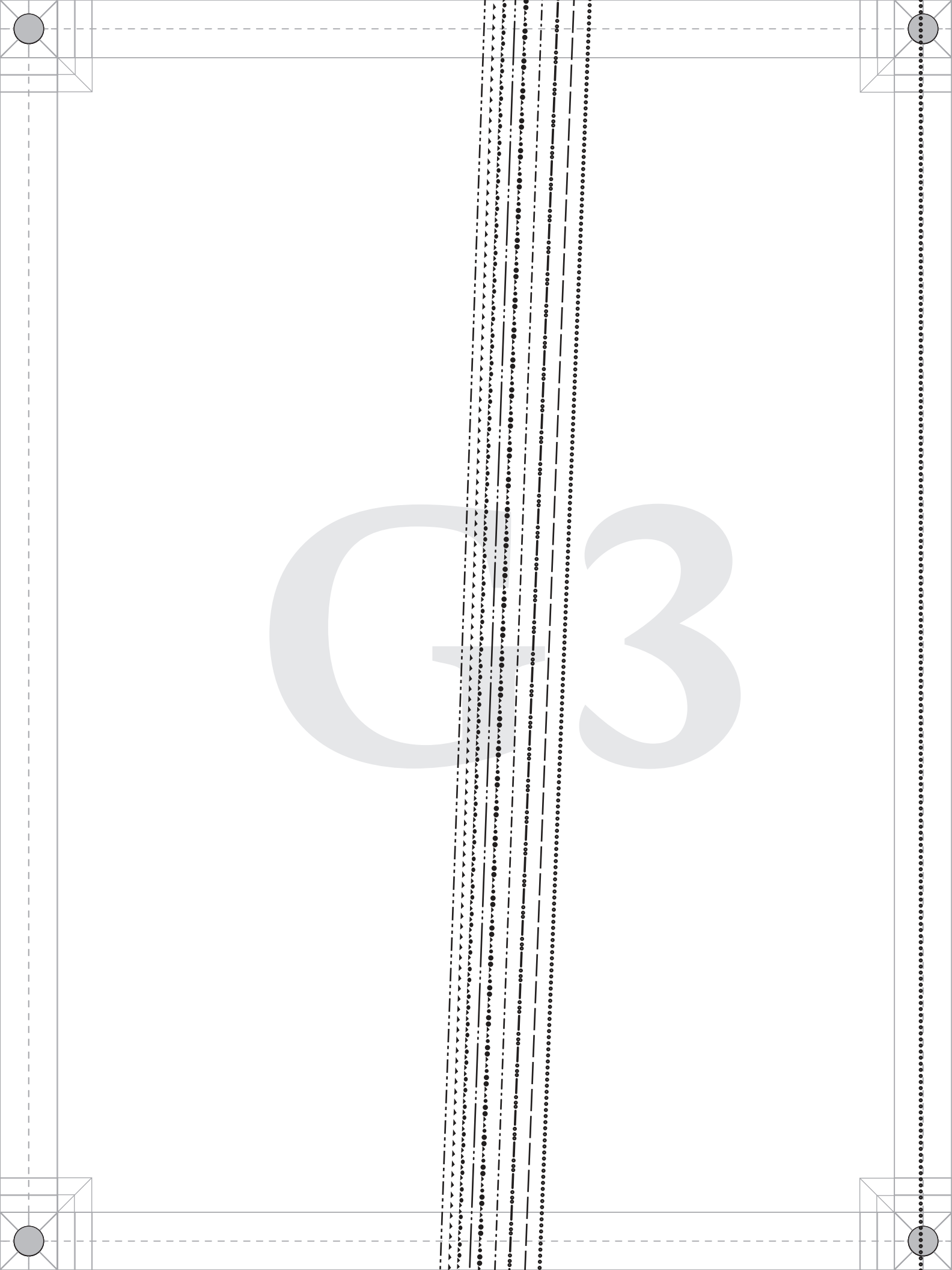

G4

G5

Q q 6

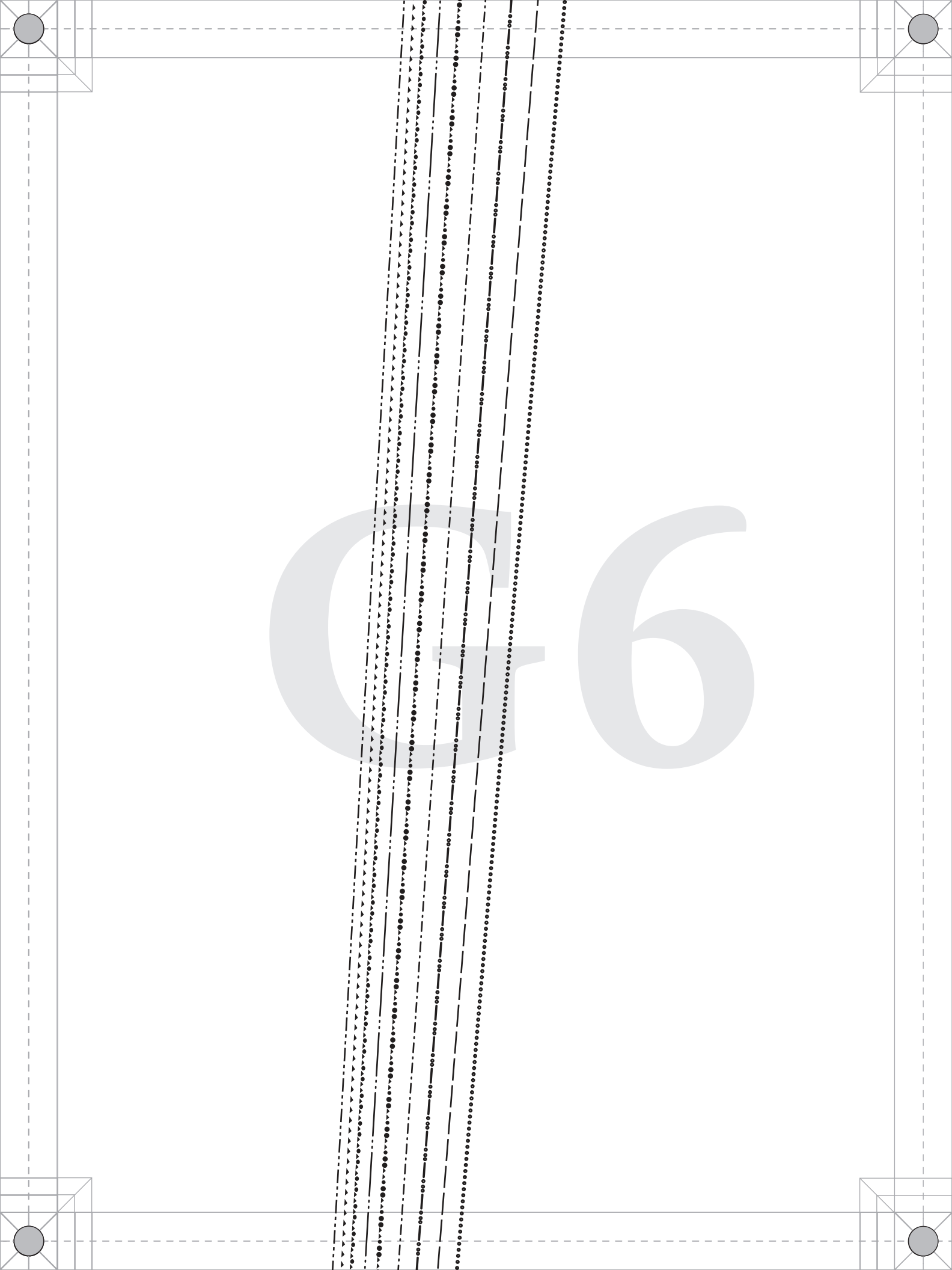
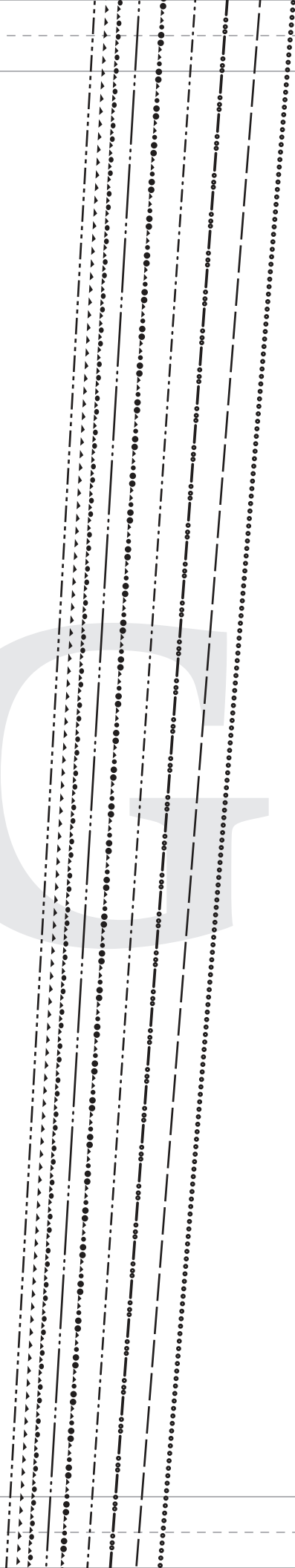

Hi

Elastic Casing Fold Line

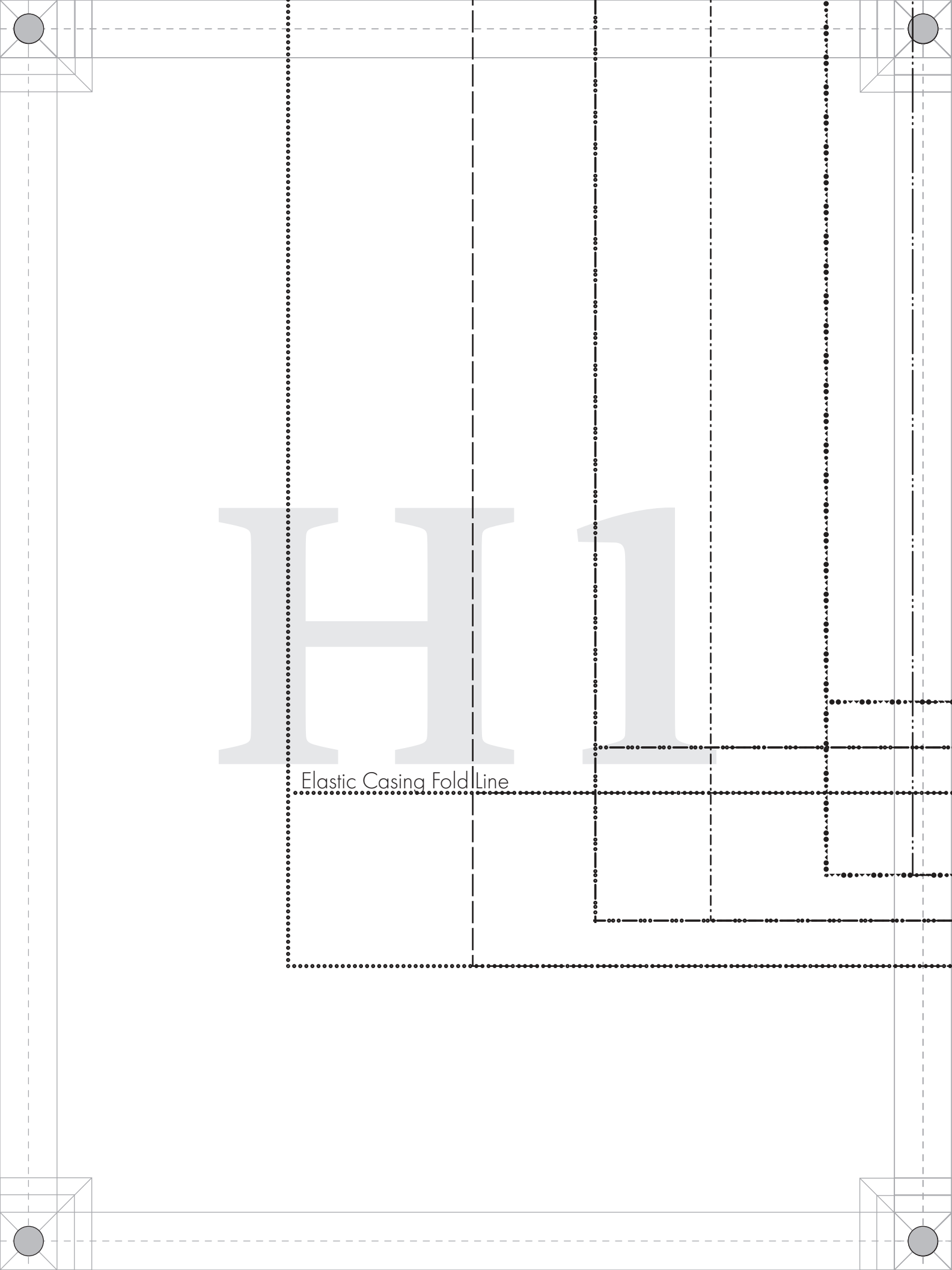

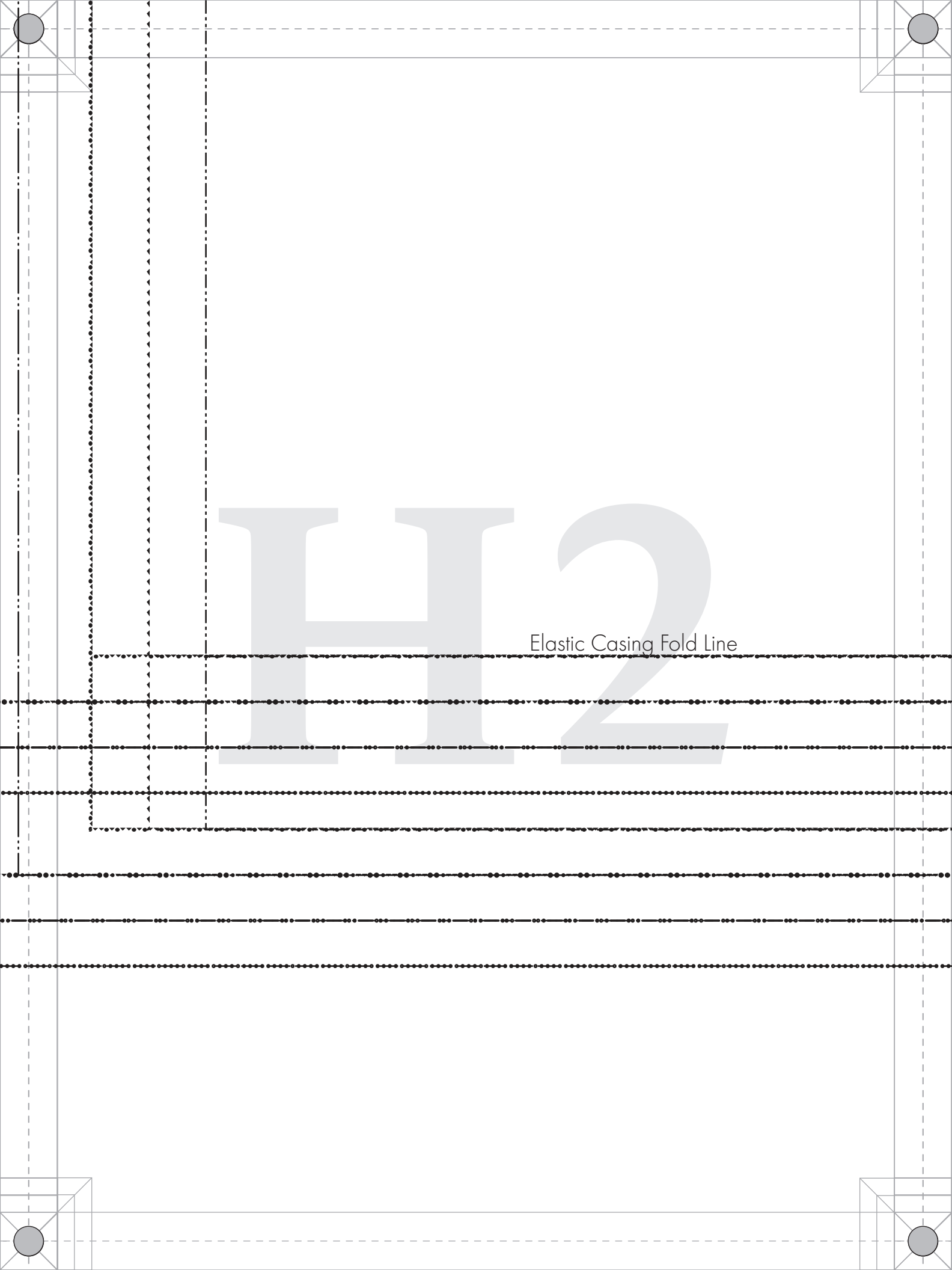

Elastic Casing Fold Line

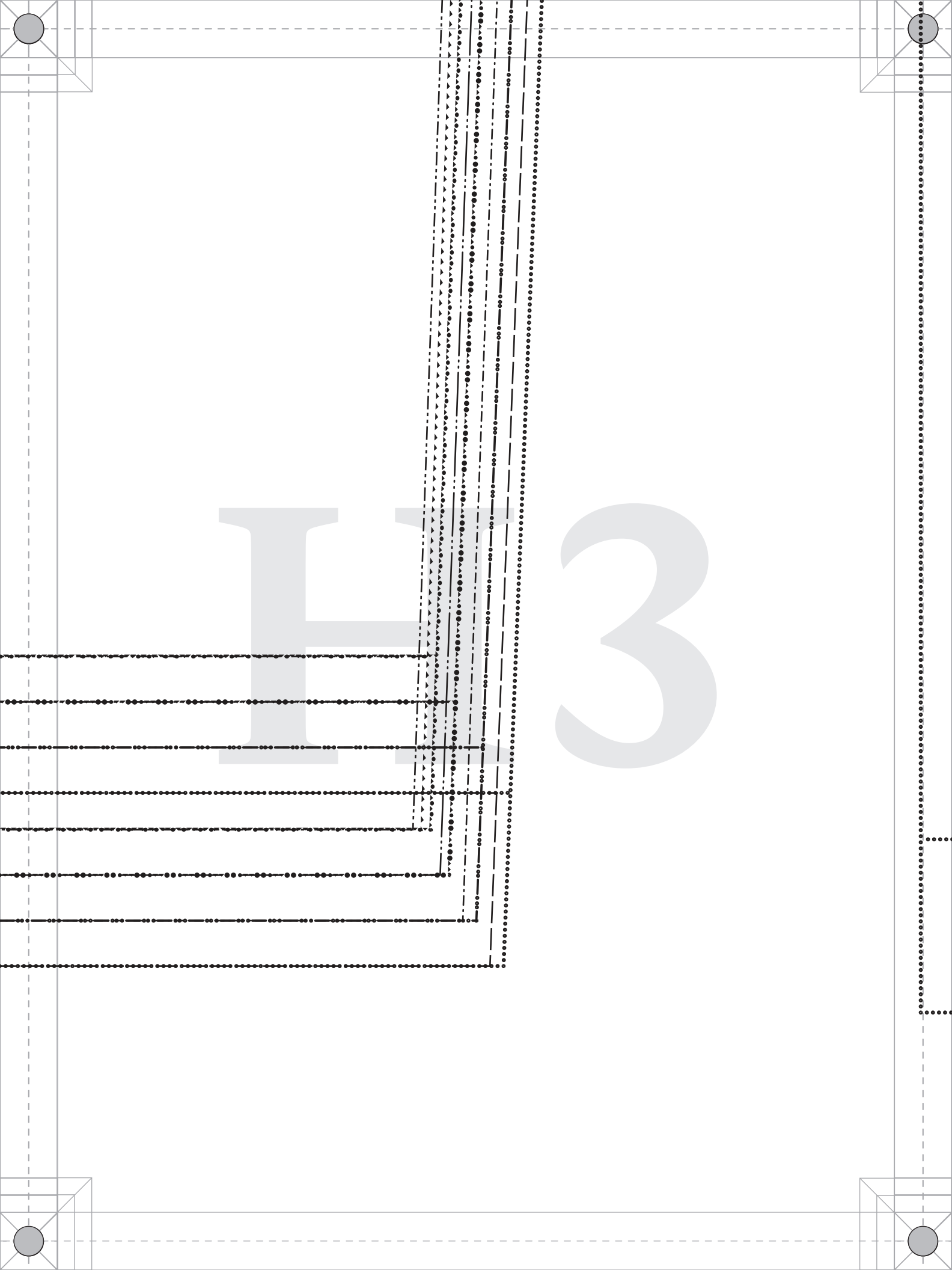

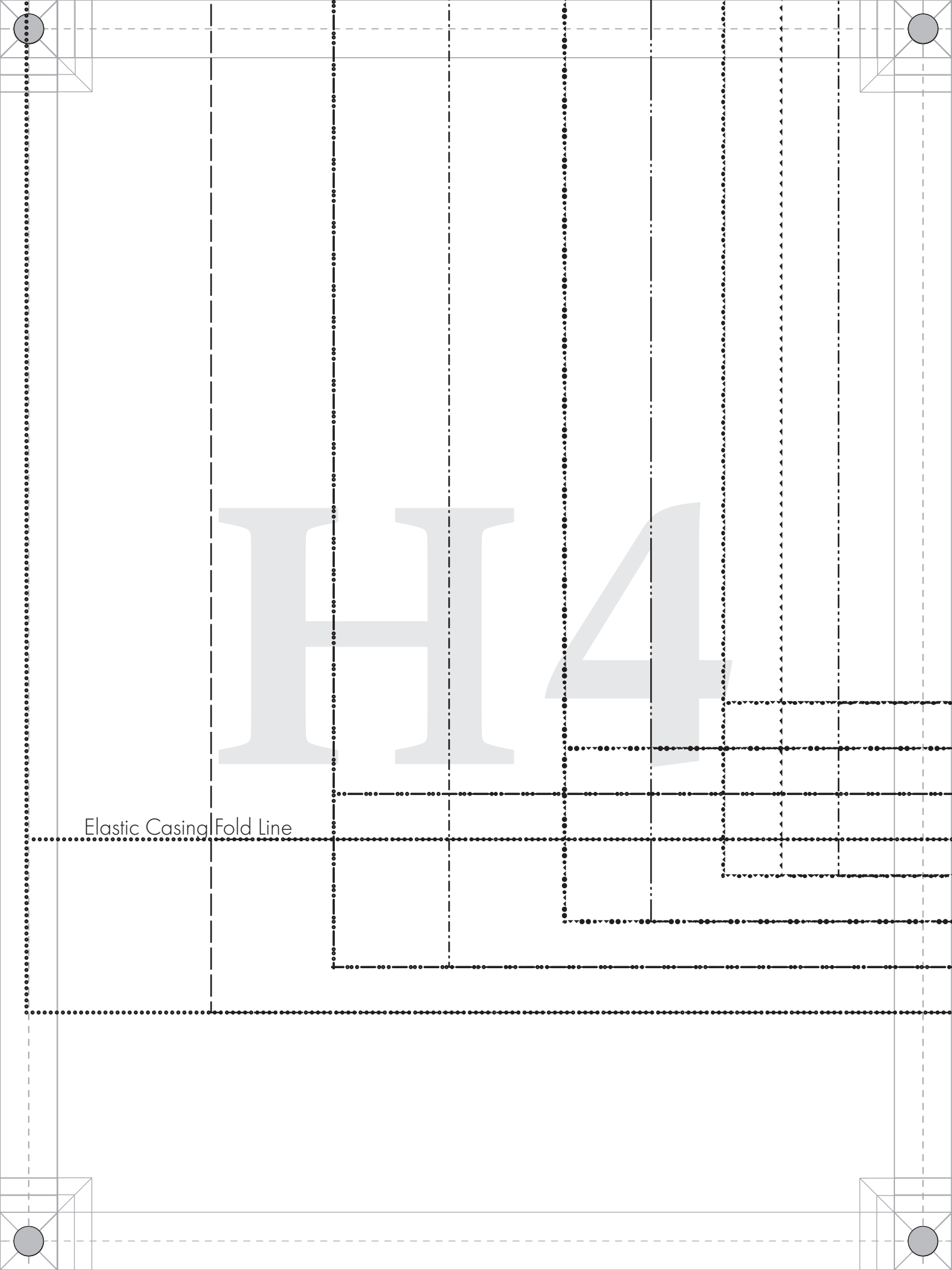

Elastic Casing Fold Line

H4

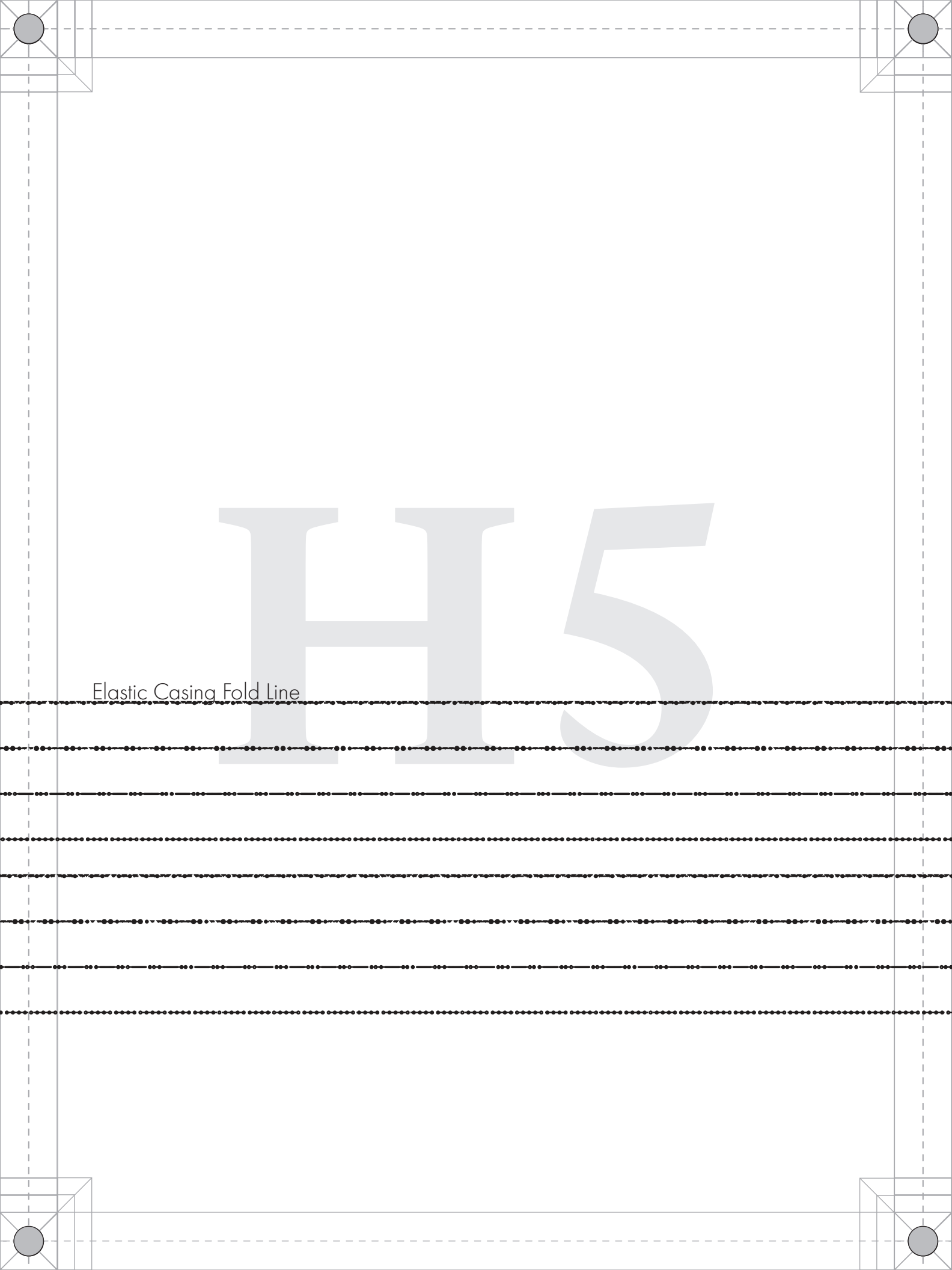

Elastic Casing Fold Line

H5

